

Contents

- Function of the physical layer :
 - is concerned with transmitting raw bits over a communication channel
 - deal with **mechanical**, **electrical**, and **timing** interfaces, and the physical **transmission medium**
- Theoretical basis for data communication
- Transmission media :
 - guided (copper wire and fiber optics)
 - wireless (terrestrial radio),
 - satellite
- three examples of communication systems :
 - the (fixed) telephone system
 - the mobile phone system
 - the cable television system

The Theoretical Basis for Data Communication

- Information can be transmitted on wires by varying some physical property such as voltage or current.
- Bandwidth-limited signals
 - The range of frequencies transmitted without being strongly attenuated is called the **bandwidth**.

The Theoretical Basis for Data Communication

- Maximum data rate for a finite bandwidth noiseless channel
 - Nyquist proved that if an arbitrary signal has been run through a low-pass filter of bandwidth H , the filtered signal can be completely reconstructed by making only $2H$ (exact) samples per second.
 - **Nyquist's theorem:**
Maximum data rate = $2H \log_2 V$ bits/sec
if the signal consists of V discrete levels
- Maximum data rate of a noisy channel
 - **Shannon's major result:** the maximum data rate of a noisy channel whose bandwidth is H Hz, and whose signal-to-noise ratio is S/N , is given by
Maximum number of bits/sec = $H \log_2(1+S/N)$

Bandwidth-Limited Signals

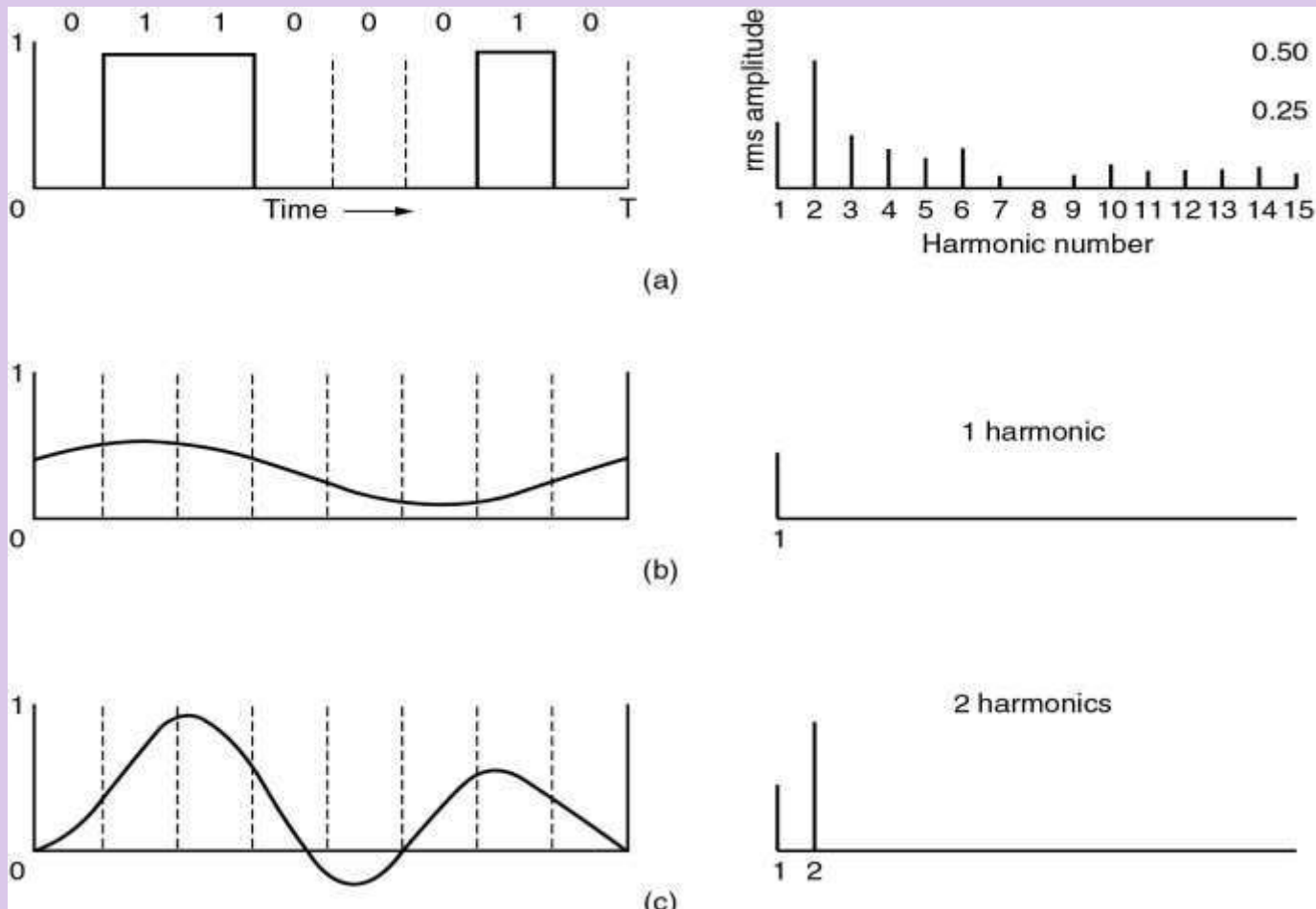

- (a) binary signal and its root-mean-square Fourier amplitudes.
(b) – (c) Successive approximations to the original signal.

Bandwidth-Limited Signals (2)

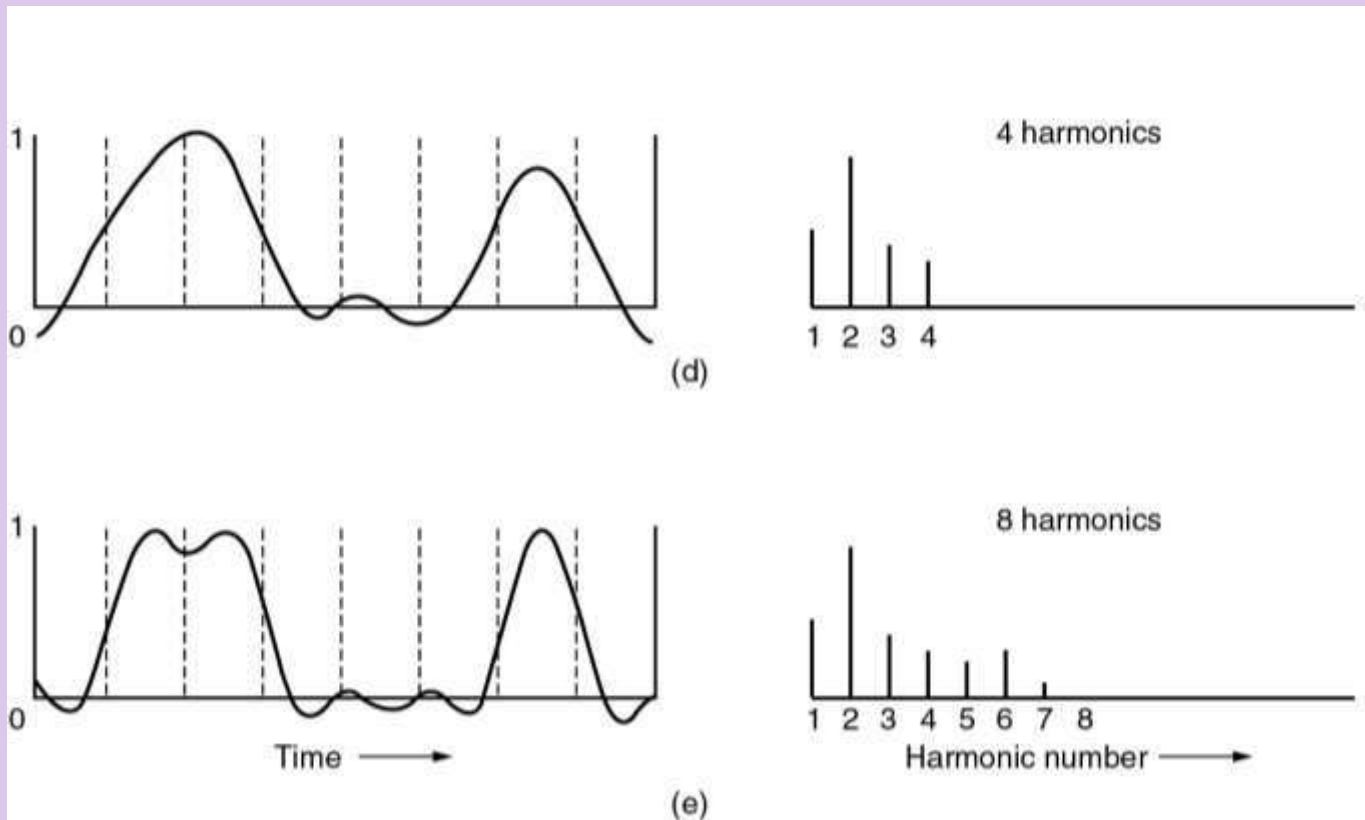

(d) – (e) Successive approximations to the original signal.

Guided Transmission Data

- Magnetic Media
- Twisted Pair
- Coaxial Cable
- Fiber Optics

Twisted Pair

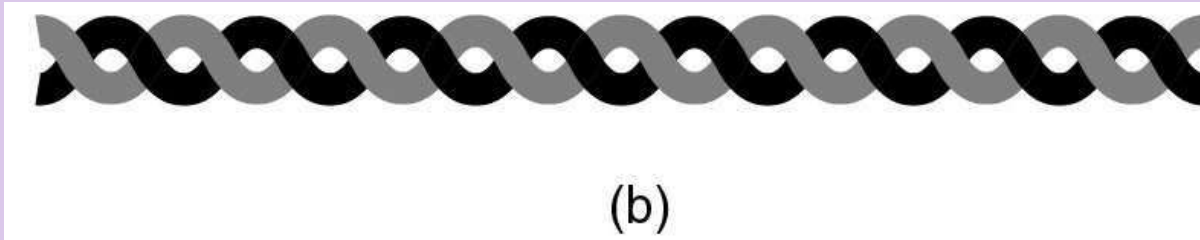
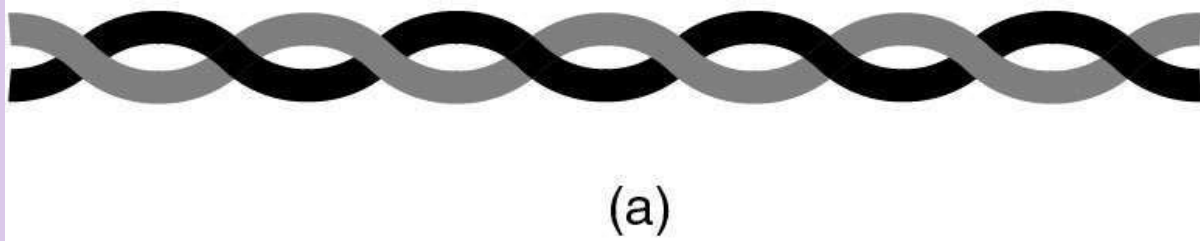

(a) Category 3 UTP.

(b) Category 5 UTP.

Coaxial Cable

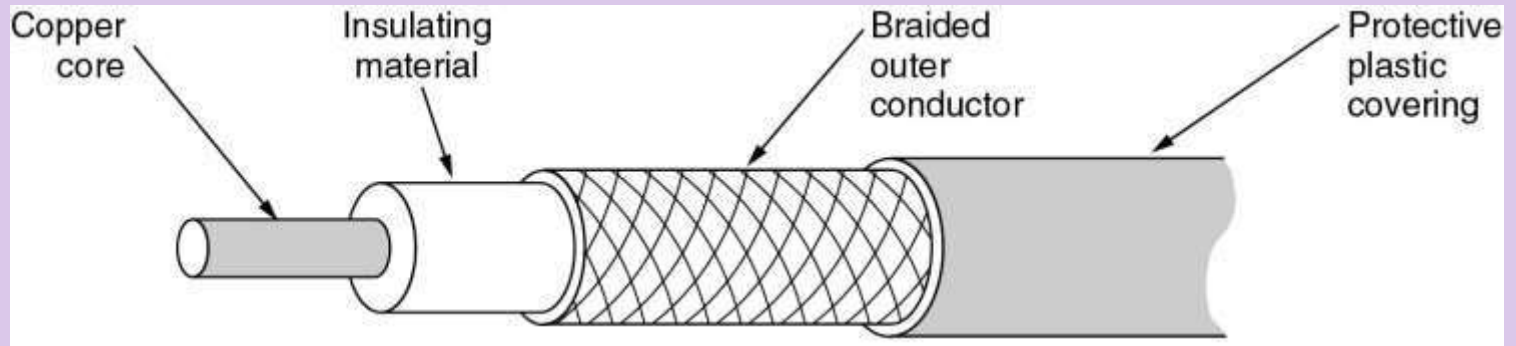

A coaxial cable.

Fiber Optics

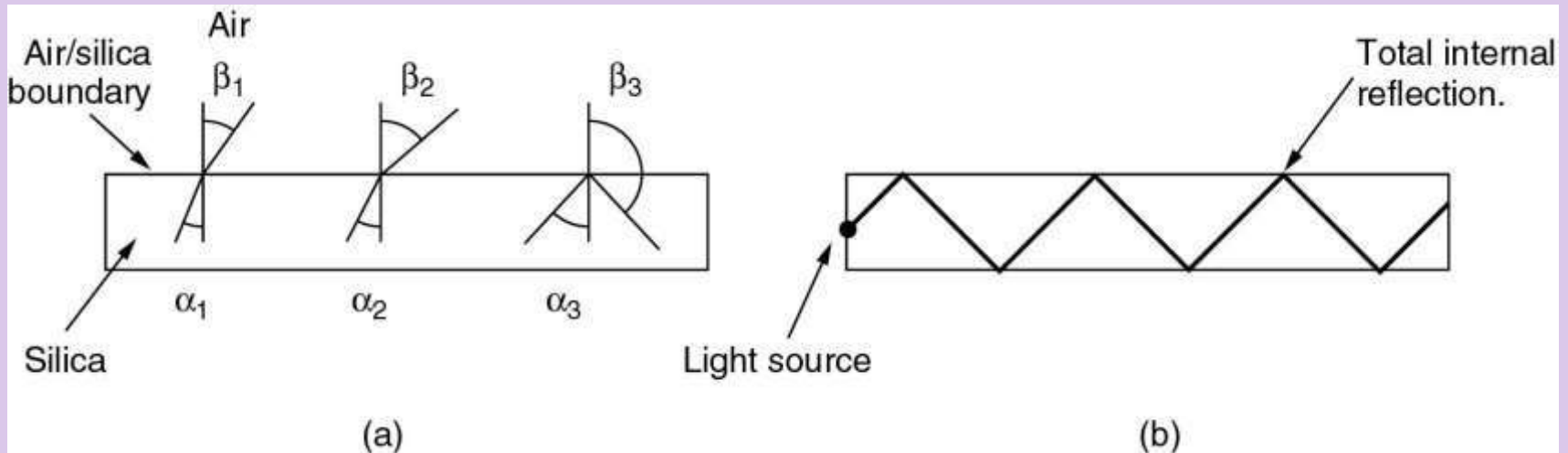

(a) Three examples of a light ray from inside a silica fiber impinging on the air/silica boundary at different angles.

(b) Light trapped by total internal reflection.

Fiber Cables

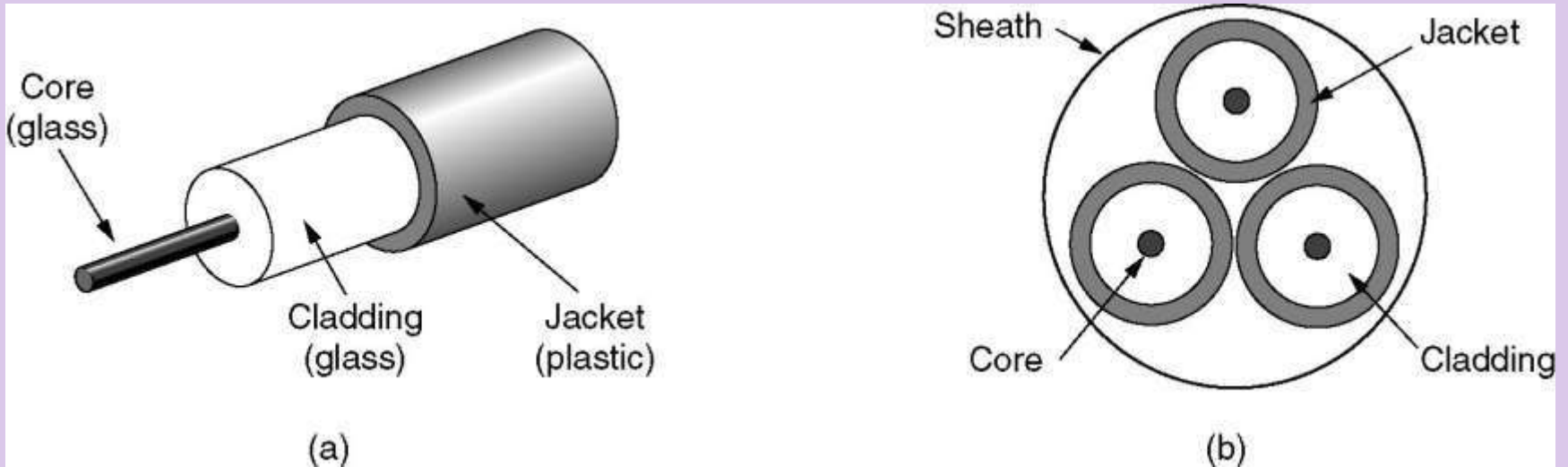

- (a) Side view of a single fiber.
- (b) End view of a sheath with three fibers.

Fiber Optic Networks

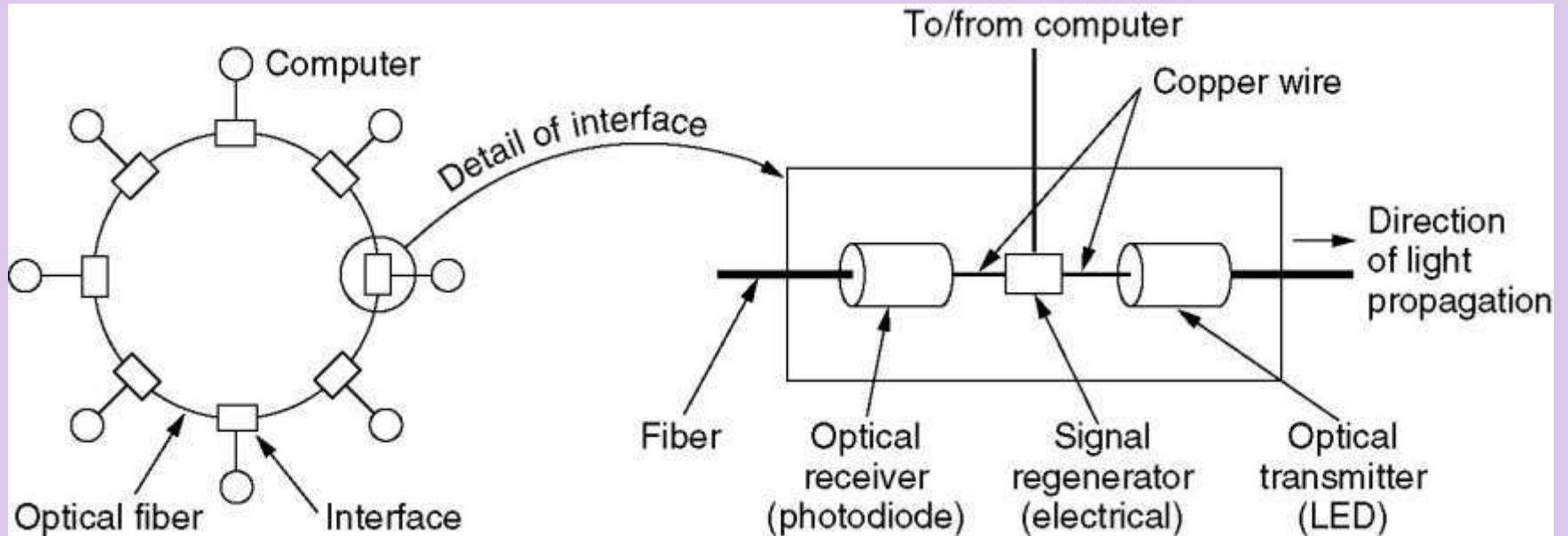

A fiber optic ring with active repeaters.

Wireless Transmission

- The Electromagnetic Spectrum
- Radio Transmission
- Microwave Transmission
- Infrared and Millimeter Waves
- Lightwave Transmission

The Electromagnetic Spectrum

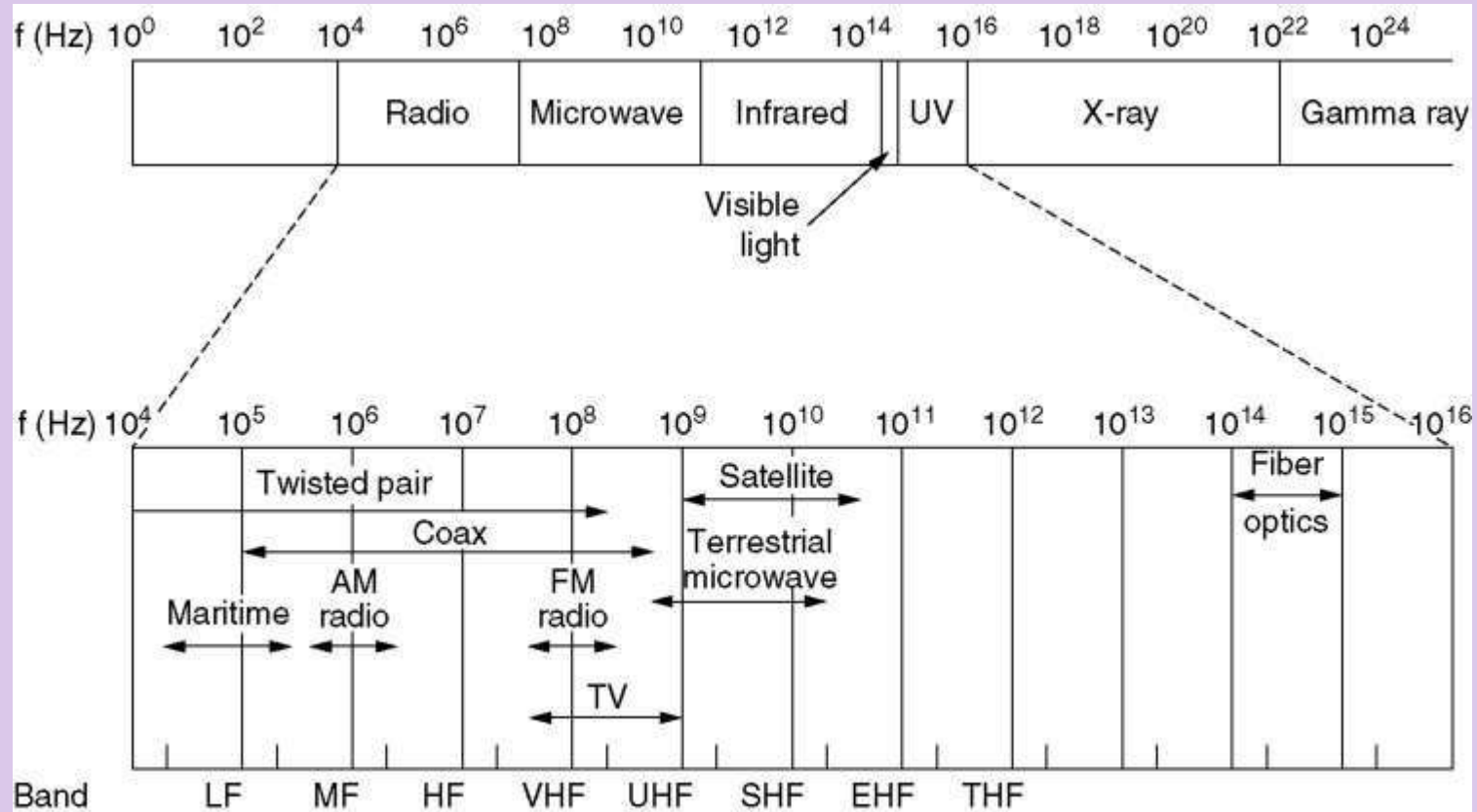

The electromagnetic spectrum and its uses for communication.

Radio Transmission

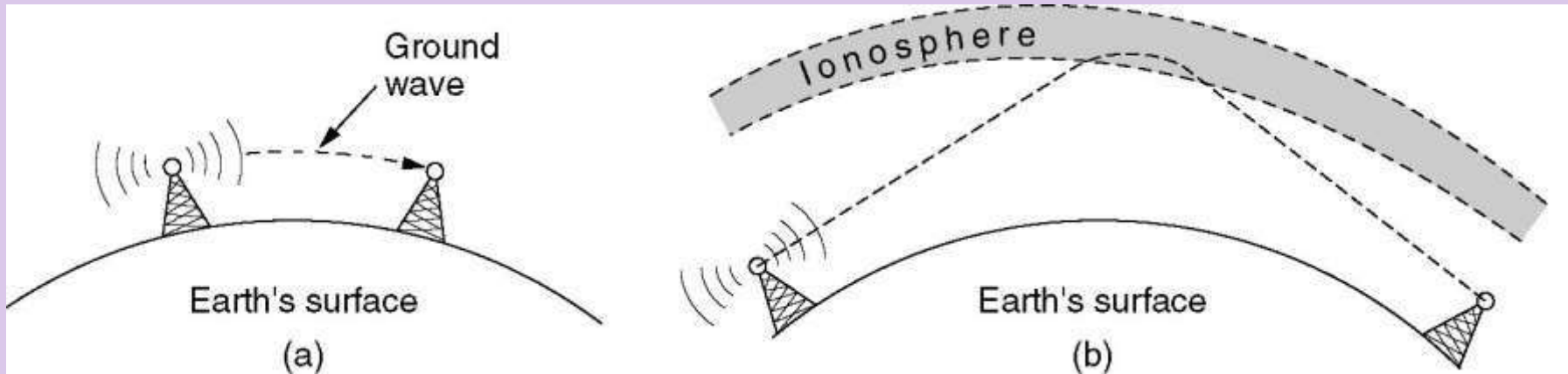

(a) In the VLF, LF, and MF bands, radio waves follow the curvature of the earth.

(b) In the HF band, they bounce off the ionosphere.

Lightwave Transmission

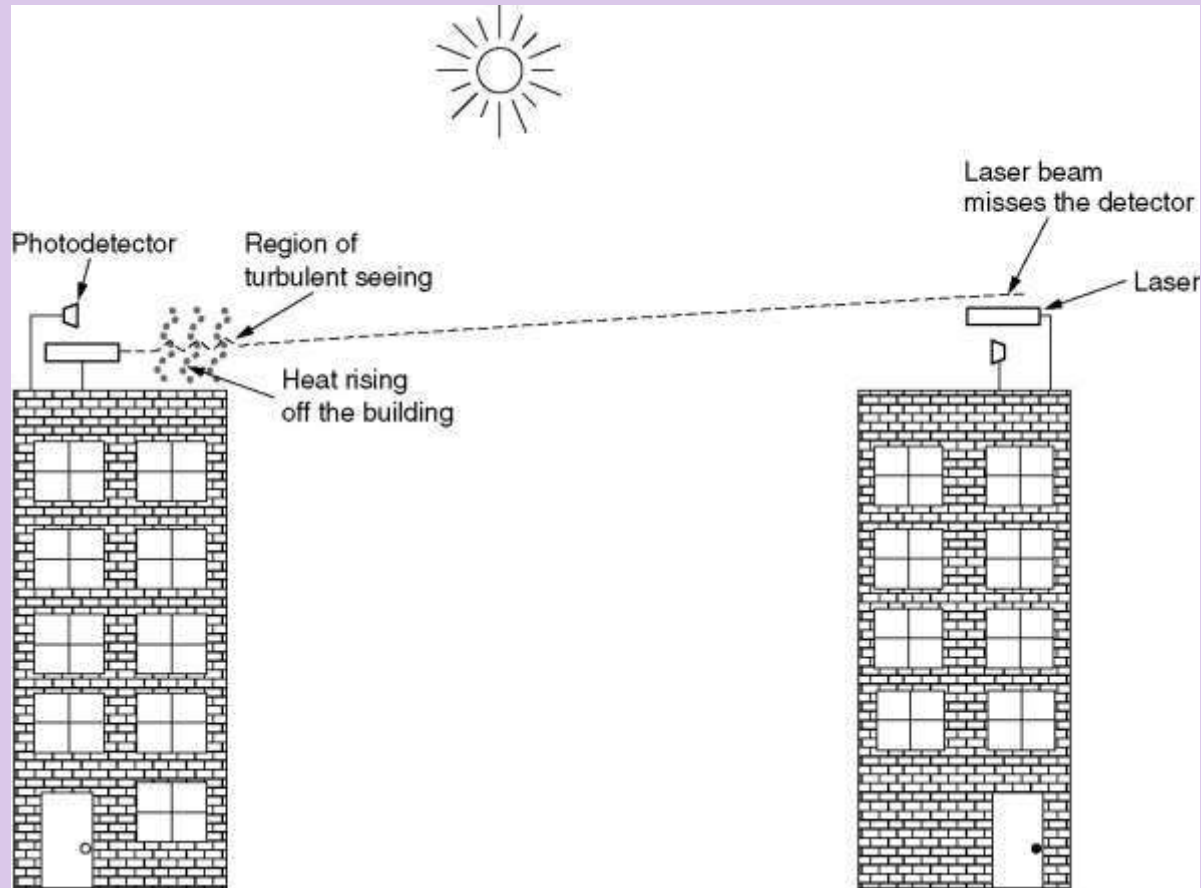

Convection currents can interfere with laser communication systems.
A bidirectional system with two lasers is pictured here.

Communication Satellites

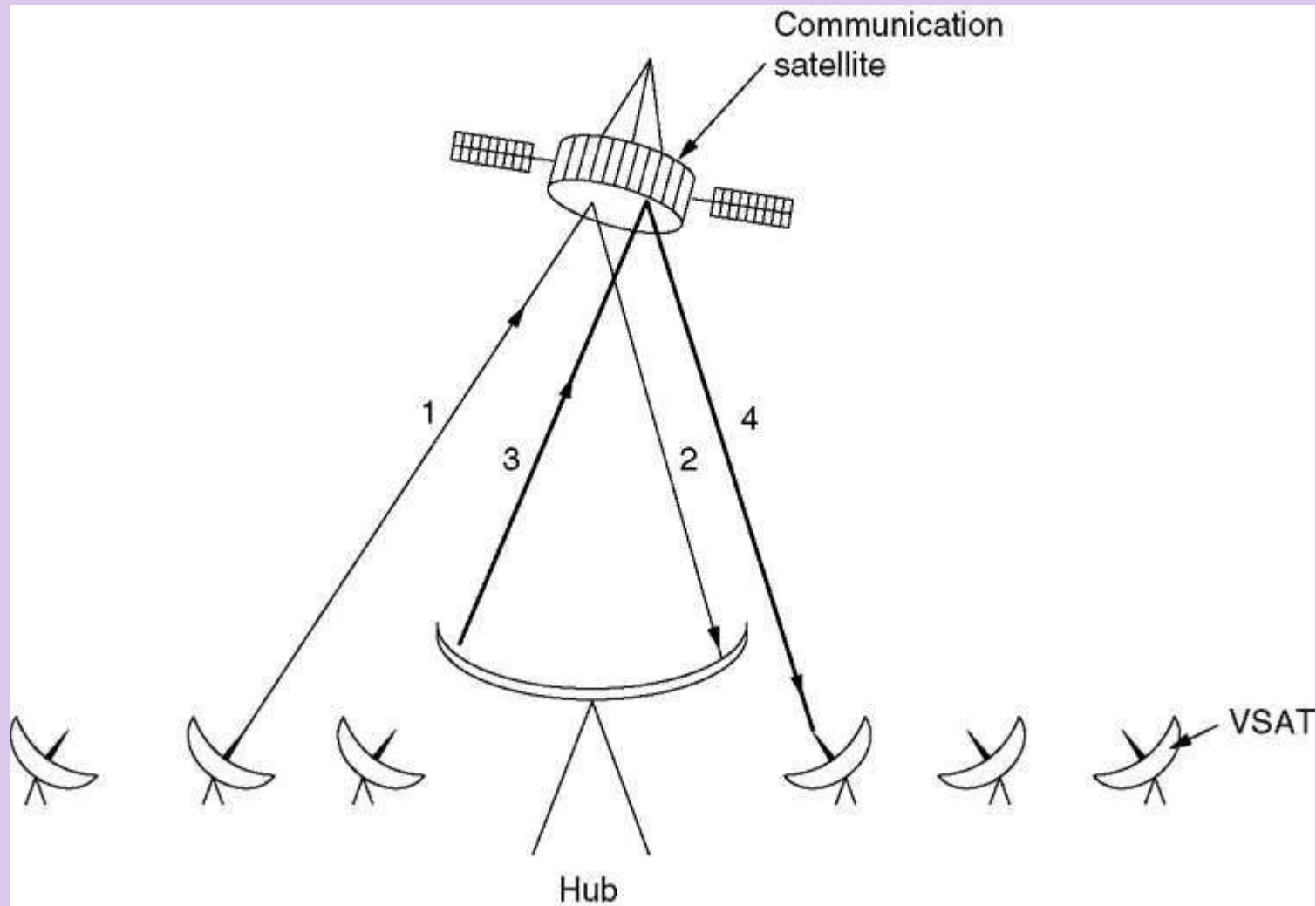

VSATs using a hub.

Public Switched Telephone System (PSTN)

- Structure of the Telephone System
- The Local Loop: Modems, ADSL and Wireless
- Trunks and Multiplexing
- Switching

Structure of the Telephone System

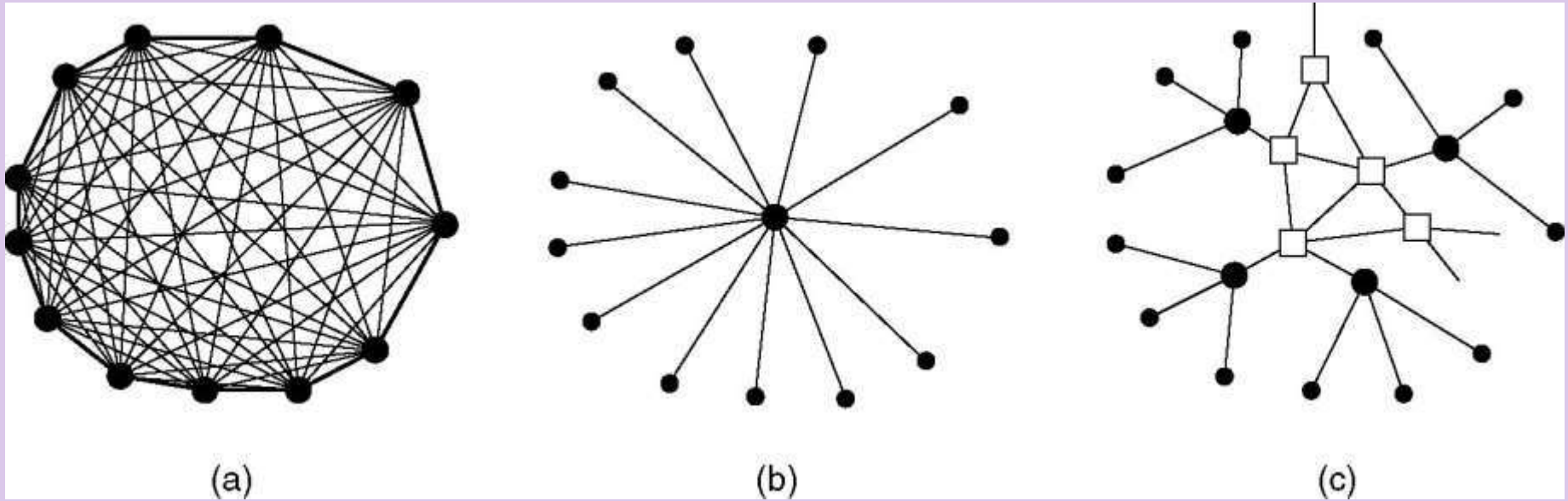

- (a) Fully-interconnected network.
- (b) Centralized switch.
- (c) Two-level hierarchy.

Structure of the Telephone System

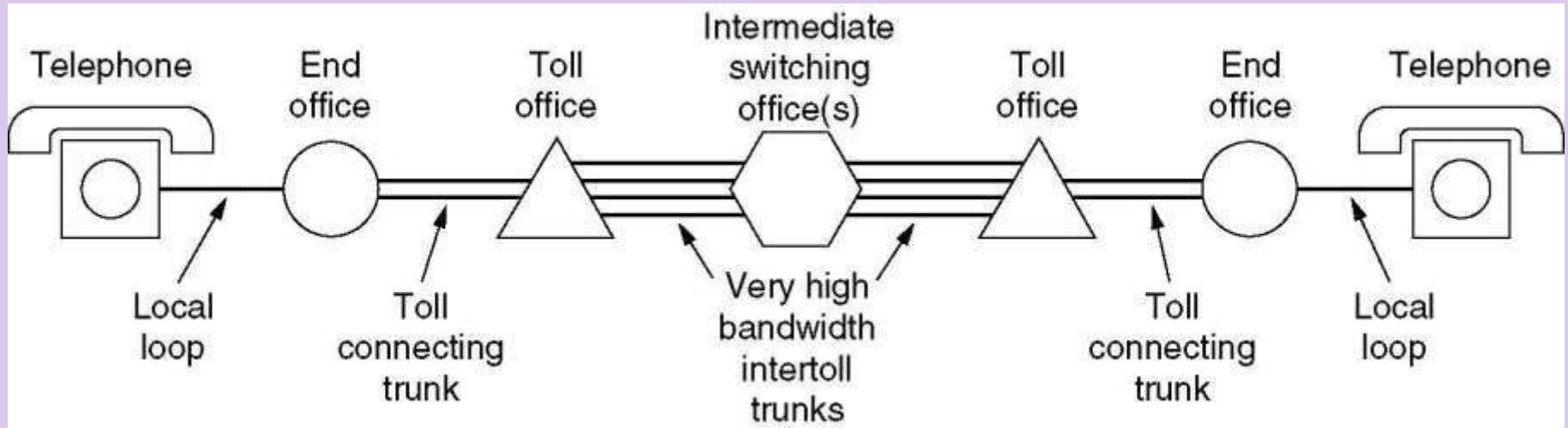

A typical circuit route for a medium-distance call.

Major Components of the Telephone System

- Local loops
 - Analog twisted pairs going to houses and businesses
- Trunks
 - Digital fiber optics connecting the switching offices
- Switching offices
 - Where calls are moved from one trunk to another

The Local Loop: Modems, ADSL, and Wireless

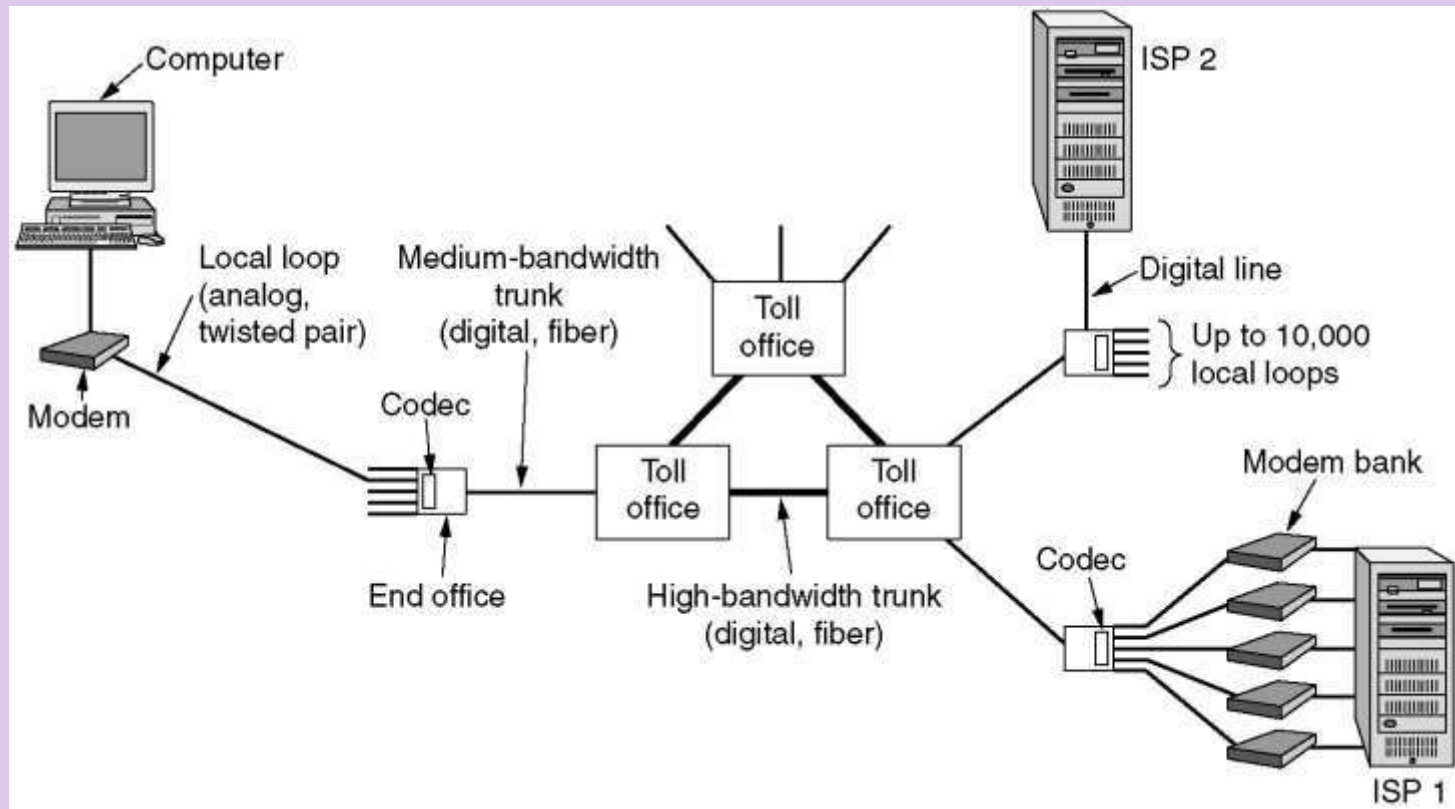

The use of both analog and digital transmissions for a computer to computer call. Conversion is done by the **modems** and **codecs**.

Modems

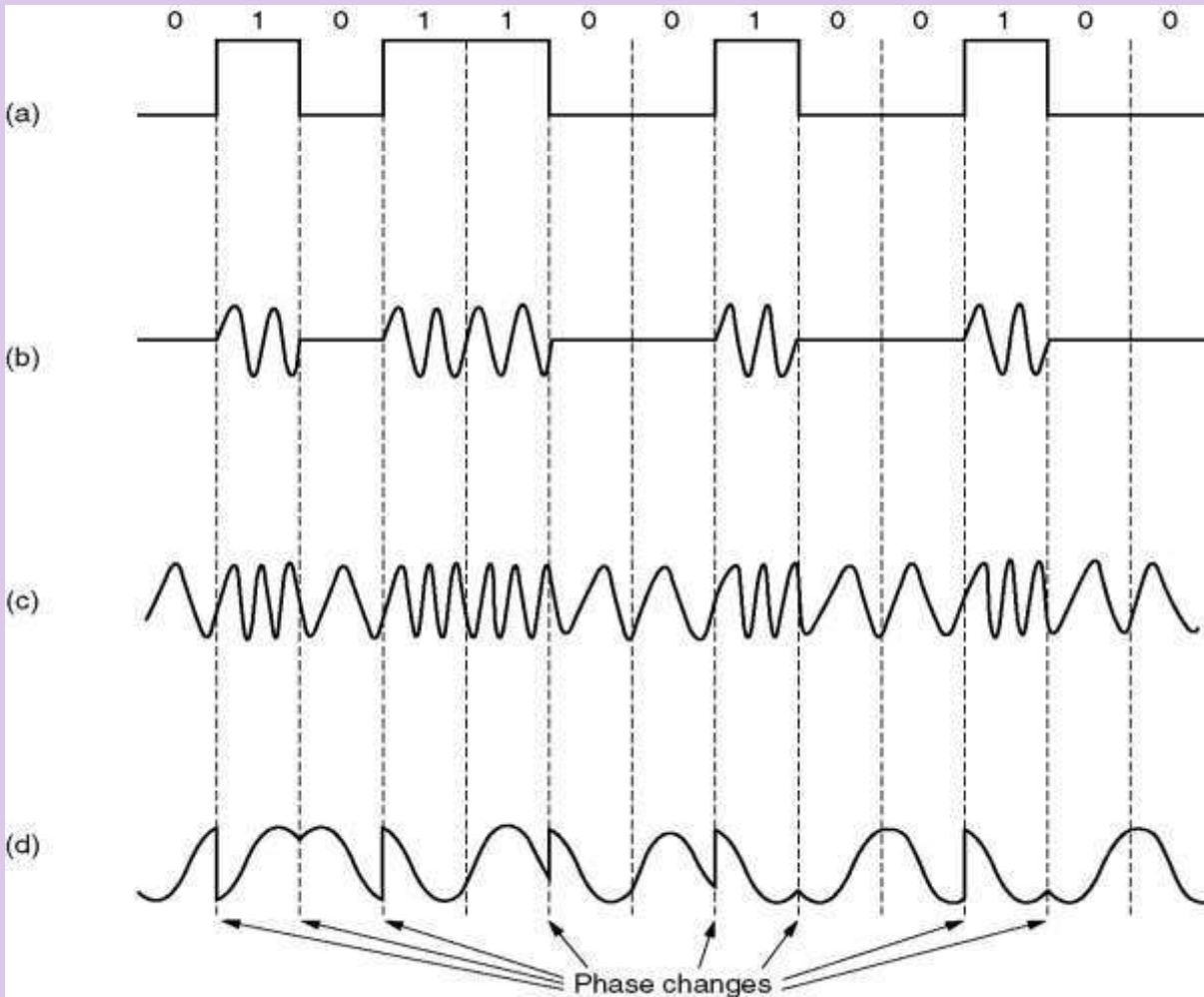

a) A binary signal

b) Amplitude modulation

c) Frequency modulation

d) Phase modulation

The number of samples per second is measured in **baud**.
During each baud, one **symbol** is sent.

Modems (2)

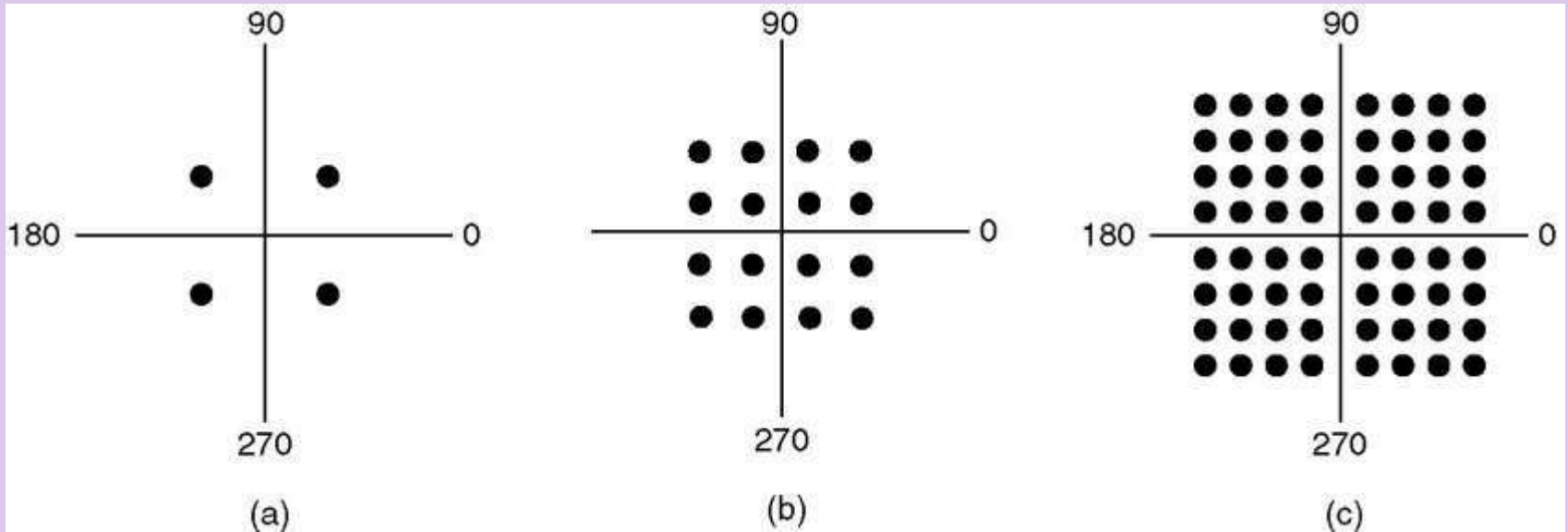

- a) QPSK.
- b) QAM-16.
- c) QAM-64.

Modems (3)

- Full duplex connection: A connection that allows traffic in both directions simultaneously
- Half duplex connection: A connection that allows traffic either way, but only one way at a time is called half duplex
- Simplex connection: A connection that allows traffic only one way

以上内容仅为本文档的试下载部分，为可阅读页数的一半内容。如要下载或阅读全文，请访问：<https://d.book118.com/437034130144006121>