



螺纹加工、 拉削加工、 珩磨与研磨

《机械制造基础》





目录

CONTENTS

- ① 螺纹加工
- ② 拉削加工
- ③ 珩磨与研磨





一、螺纹加工

- ◆ 螺纹的车削加工
- ◆ 螺纹的铣削加工
- ◆ 攻螺纹和套螺纹
- ◆ 螺纹的滚压加工





螺纹的车削加工

用螺纹车刀车削内、外螺纹

在卧式车床和丝杠车床上用螺纹车刀车削螺纹时，螺纹的廓形由车刀的刃形所决定，而螺距则是依靠调整机床的运动来保证的。这种方法具有刀具简单、适应性广、无需专用设备的优点，但生产率不高，主要用于单件、小批生产。

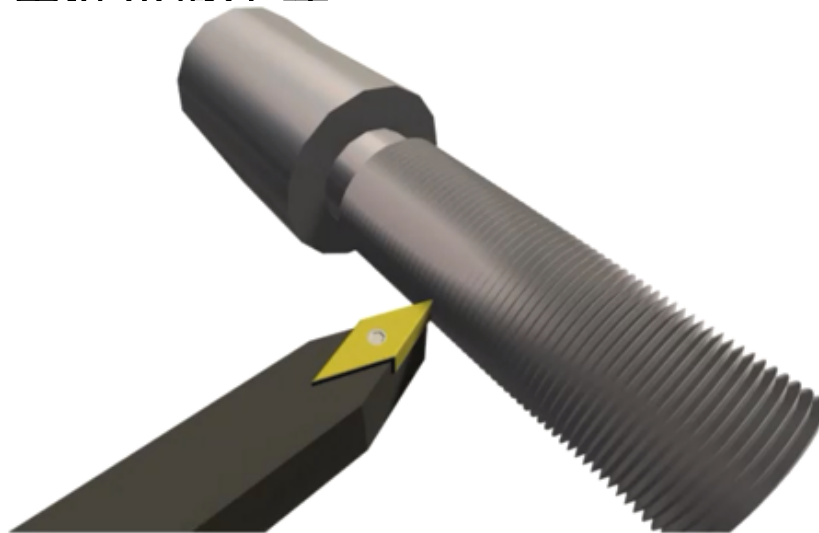



螺纹的车削加工 用螺纹梳刀车削螺纹

切削部分 校准部分



图2-8-1 螺纹梳刀的刀齿



图2-8-2 螺纹梳刀的形式
a)平体螺纹梳刀 b)棱体螺纹梳刀 c)圆体螺纹梳刀

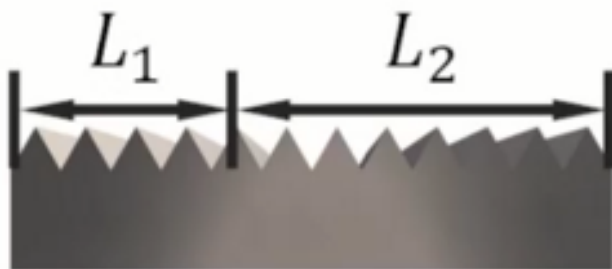

螺纹的铣削加工 盘形铣刀铣削螺纹

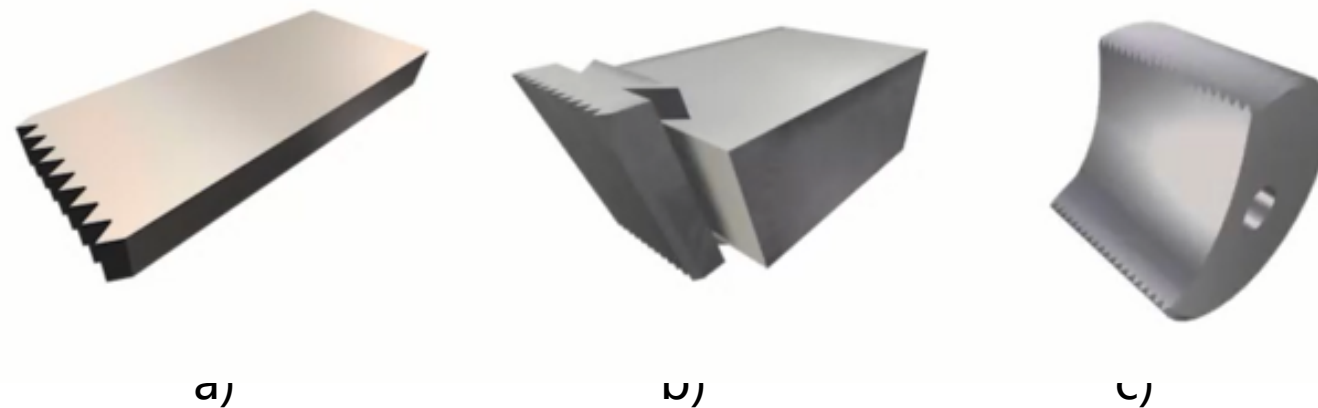

图2-8-3 盘铣刀铣削螺纹



螺纹的铣削加工 旋风法铣削螺纹

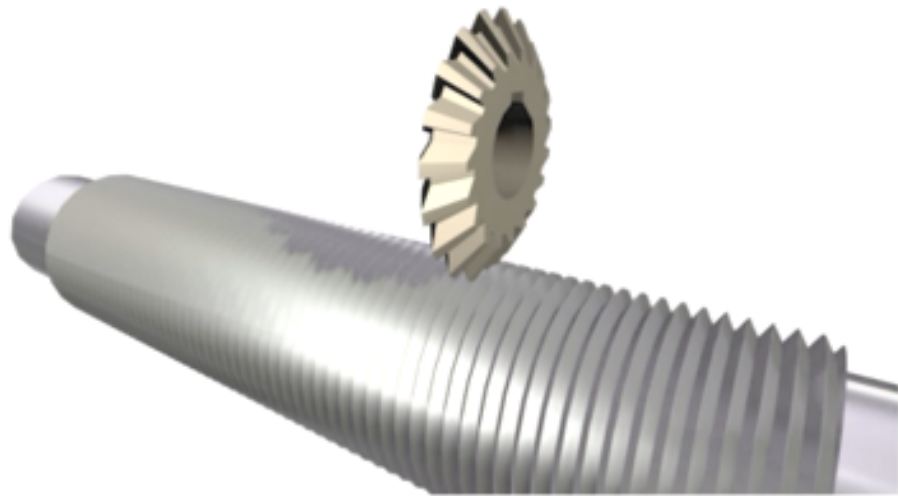

图2-8-4 旋风法铣削螺纹



攻螺纹和套螺纹

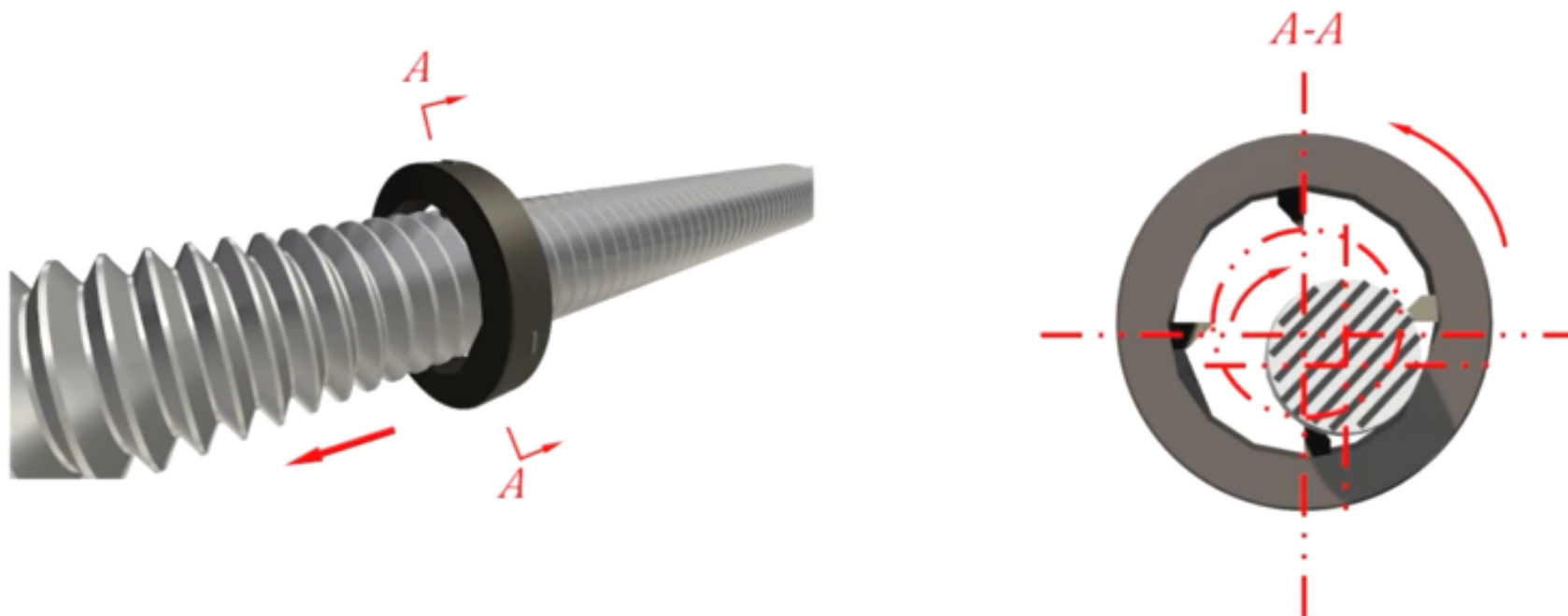

图2-8-5 手工操作加工螺纹
a)攻螺纹 b)套螺纹



攻螺纹和套螺纹 攻螺纹

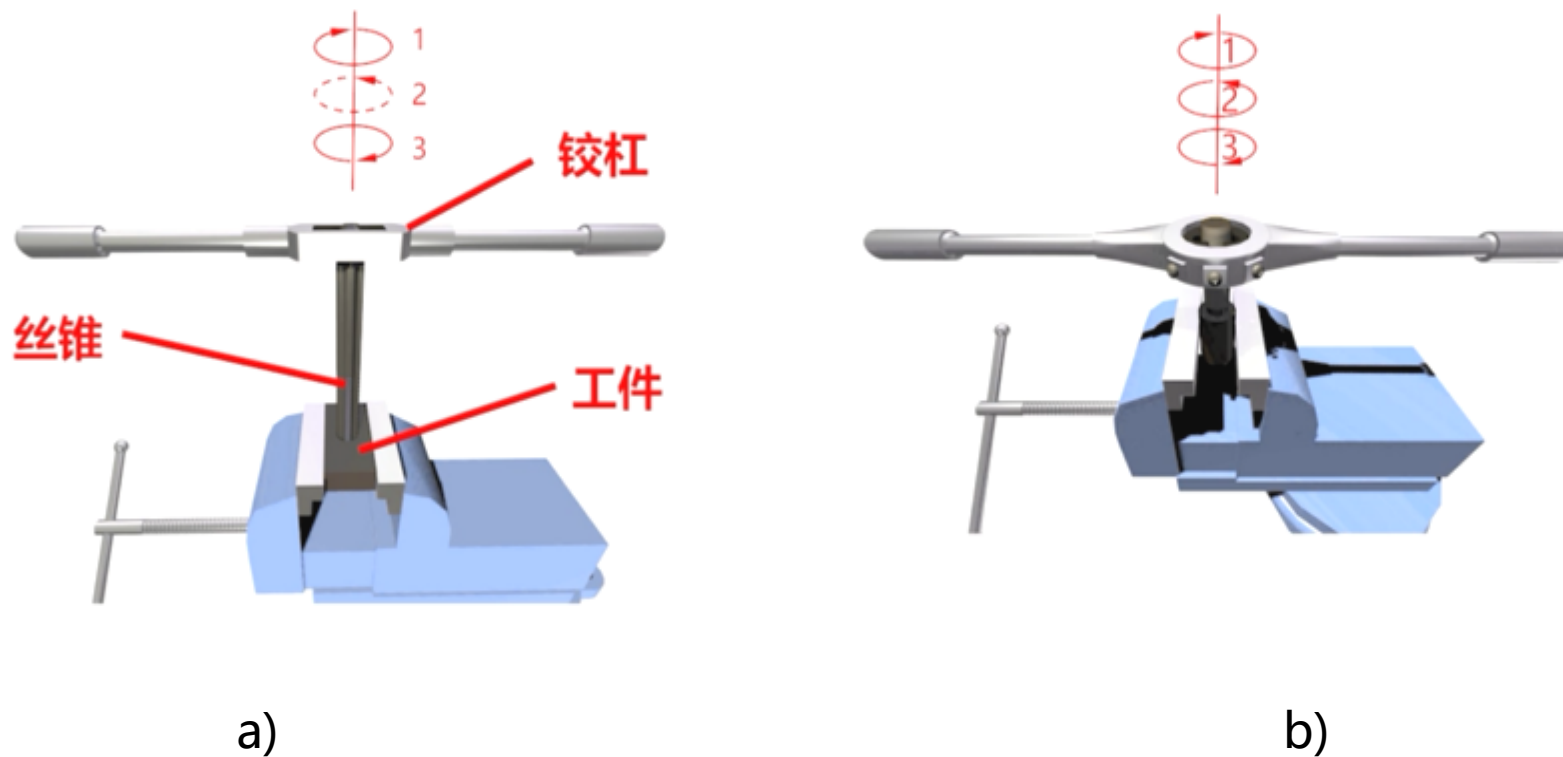

图2-8-6 常用丝锥的结构



攻螺纹和套螺纹 攻螺纹

底孔直径大小可以用经验公式求得，也可直接查表。这里介绍经验公式法。

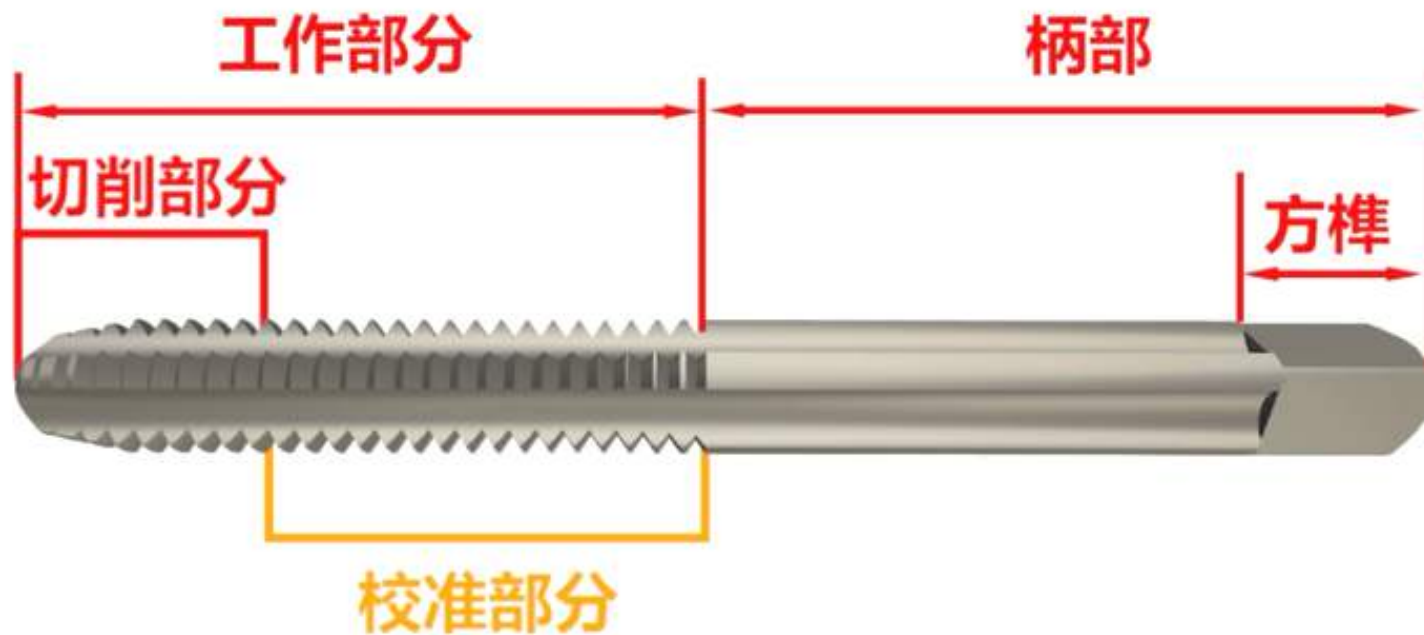
加工钢等塑性较大的材料，扩张力中等的条件下，攻螺纹前，钻螺纹底孔用钻头的直径

$$D_{\text{钻}} = D - P, \text{ 其中 } D \text{ 为螺纹大径(mm); } P \text{ 为螺距(mm).}$$

加工铸铁等塑性较小的材料，扩张力较小的条件下， $D_{\text{钻}} = D - (1.05 \sim 1.1)P$

底孔深度的确定。攻不通孔的螺纹时，因丝锥不能攻到底，所以孔的深度要大于螺纹长度，其大小可按下式计算，即

$$\text{钻孔深度} = \text{所需螺孔深度} + 0.7D$$



攻螺纹和套螺纹 套螺纹



图2-8-7 圆板牙



攻螺纹和套螺纹 套螺纹



图2-8-8 圆板牙架



攻螺纹和套螺纹 套螺纹

套螺纹方法一套：螺纹前圆杆直径的确定：套螺纹前应检查圆杆直径，圆杆直径太大难以套入，太小套出的螺纹牙齿不完整，圆杆直径应略小于螺纹大径的基本尺寸 d 。一般经验公式计算：

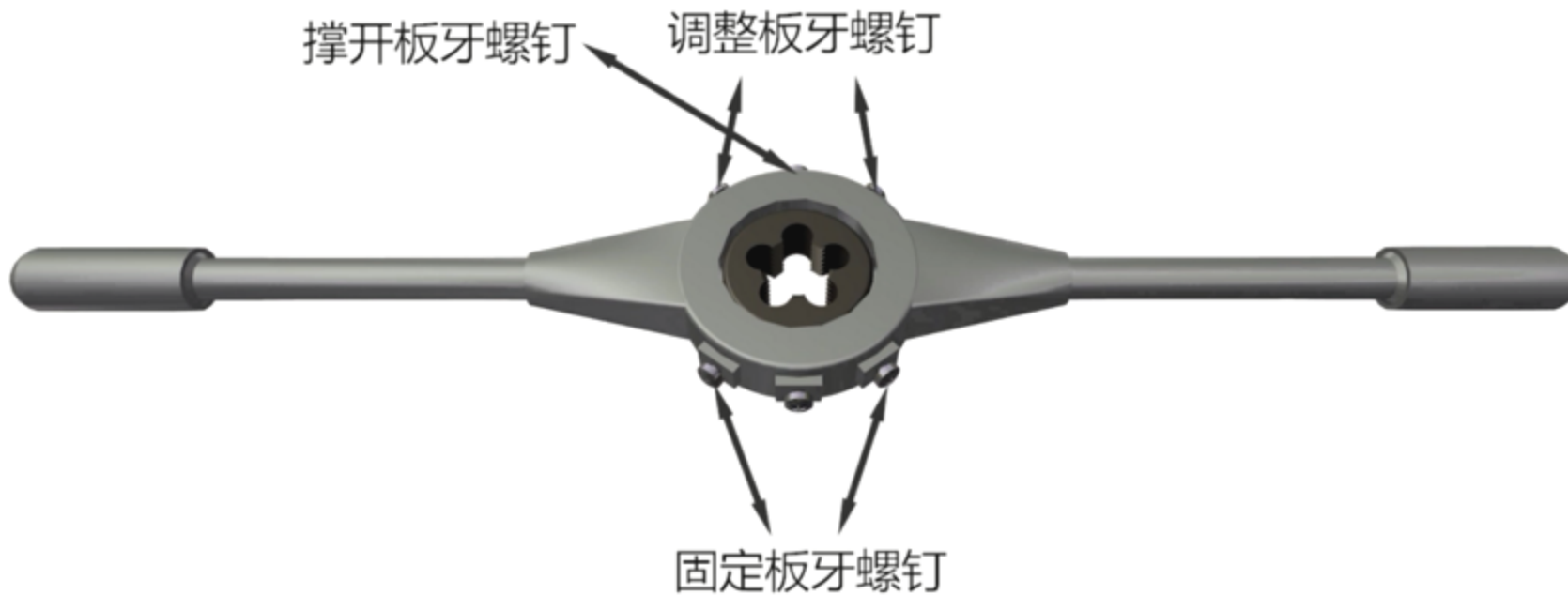
圆杆直径 $d_{\#} = d - 0.13P$ (d 为螺纹大径， P 为螺距)；

也可以查表确定圆杆直径。



螺纹的滚压加工 搓螺纹



图2-8-9 搓螺纹原理



螺纹的滚压加工

滚螺纹

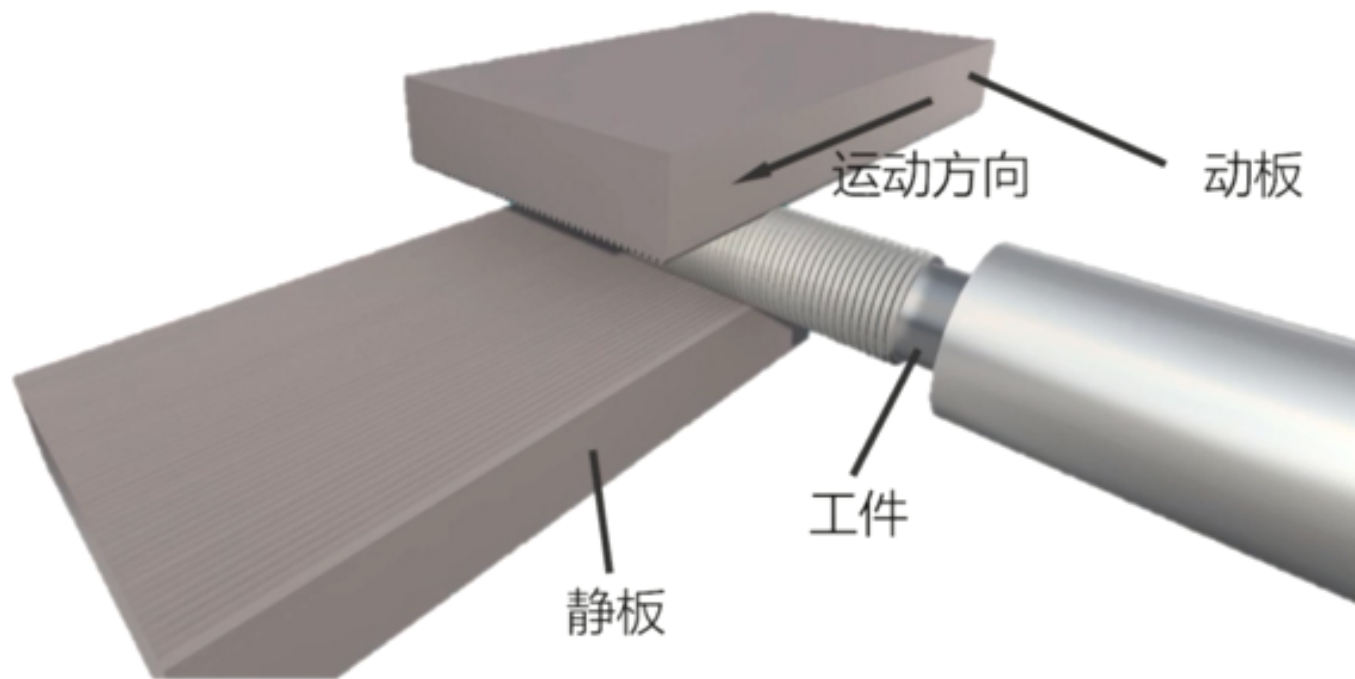

图2-8-10 滚螺纹原理



二、拉削加工

- ◆ 拉削加工范围
- ◆ 拉削加工特点
- ◆ 拉床
- ◆ 拉刀
- ◆ 拉削方式
- ◆ 拉削加工方法

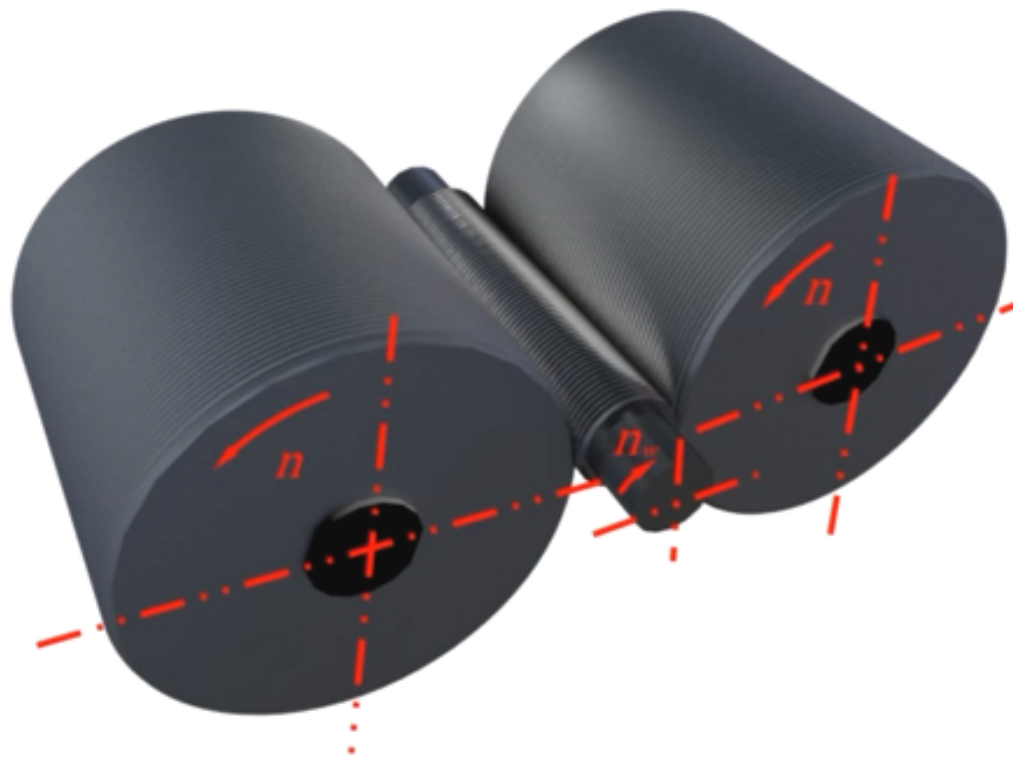



拉削加工范围









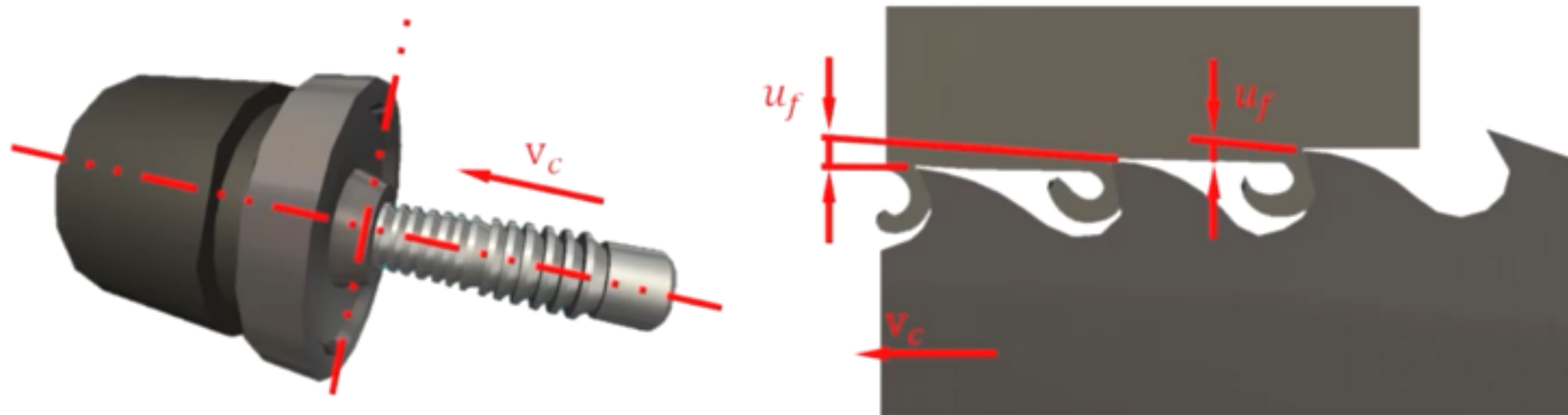
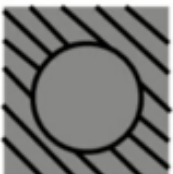
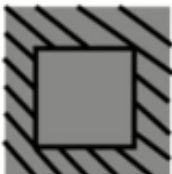
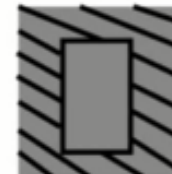
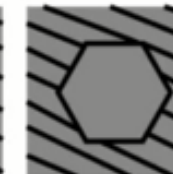

图2-8-11 拉削方式

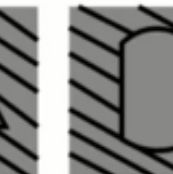

拉削加工范围

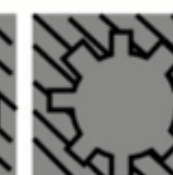
表2-8-1 拉削加工范围

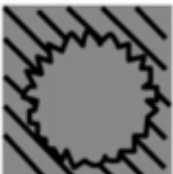
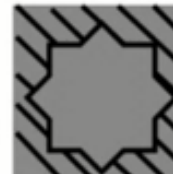
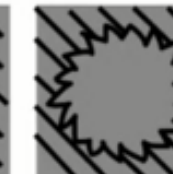
内表面加工范围	     	<p>图a—圆孔;图b—方孔;图c—长方形孔;图d—六角孔;图e—三角孔;图f—鼓形孔;图g键槽;图h—双键槽;图i—四键槽;图j、k—花键;图l—尖齿孔;图m—内齿轮;图n—交叉方孔;图o—内圆锯齿孔</p>
	     	
	  	

以上内容仅为本文档的试下载部分，为可阅读页数的一半内容。如要下载或阅读全文，请访问：
<https://d.book118.com/466234024242011013>