

INTERNATIONAL STANDARD

NORME INTERNATIONALE

**Industrial systems, installations and equipment and industrial products –
Labelling of cables and cores**

**Systèmes industriels, installations et appareils et produits industriels –
Etiquetage des câbles et des conducteurs isolés**





THIS PUBLICATION IS COPYRIGHT PROTECTED

Copyright © 2008 IEC, Geneva, Switzerland

All rights reserved. Unless otherwise specified, no part of this publication may be reproduced or utilized in any form or by any means, electronic or mechanical, including photocopying and microfilm, without permission in writing from either IEC or IEC's member National Committee in the country of the requester.

If you have any questions about IEC copyright or have an enquiry about obtaining additional rights to this publication, please contact the address below or your local IEC member National Committee for further information.

Droits de reproduction réservés. Sauf indication contraire, aucune partie de cette publication ne peut être reproduite ni utilisée sous quelque forme que ce soit et par aucun procédé, électronique ou mécanique, y compris la photocopie et les microfilms, sans l'accord écrit de la CEI ou du Comité national de la CEI du pays du demandeur.

Si vous avez des questions sur le copyright de la CEI ou si vous désirez obtenir des droits supplémentaires sur cette publication, utilisez les coordonnées ci-après ou contactez le Comité national de la CEI de votre pays de résidence.

IEC Central Office
3, rue de Varembe
CH-1211 Geneva 20
Switzerland
Email: inmail@iec.ch
Web: www.iec.ch

About the IEC

The International Electrotechnical Commission (IEC) is the leading global organization that prepares and publishes International Standards for all electrical, electronic and related technologies.

About IEC publications

The technical content of IEC publications is kept under constant review by the IEC. Please make sure that you have the latest edition, a corrigenda or an amendment might have been published.

- Catalogue of IEC publications: www.iec.ch/searchpub

The IEC on-line Catalogue enables you to search by a variety of criteria (reference number, text, technical committee,...). It also gives information on projects, withdrawn and replaced publications.

- IEC Just Published: www.iec.ch/online_news/justpub

Stay up to date on all new IEC publications. Just Published details twice a month all new publications released. Available on-line and also by email.

- Electropedia: www.electropedia.org

The world's leading online dictionary of electronic and electrical terms containing more than 20 000 terms and definitions in English and French, with equivalent terms in additional languages. Also known as the International Electrotechnical Vocabulary online.

- Customer Service Centre: www.iec.ch/webstore/custserv

If you wish to give us your feedback on this publication or need further assistance, please visit the Customer Service Centre FAQ or contact us:

Email: csc@iec.ch
Tel.: +41 22 919 02 11
Fax: +41 22 919 03 00

A propos de la CEI

La Commission Electrotechnique Internationale (CEI) est la première organisation mondiale qui élabore et publie des normes internationales pour tout ce qui a trait à l'électricité, à l'électronique et aux technologies apparentées.

A propos des publications CEI

Le contenu technique des publications de la CEI est constamment revu. Veuillez vous assurer que vous possédez l'édition la plus récente, un corrigendum ou amendement peut avoir été publié.

- Catalogue des publications de la CEI: www.iec.ch/searchpub/cur_fut-f.htm

Le Catalogue en-ligne de la CEI vous permet d'effectuer des recherches en utilisant différents critères (numéro de référence, texte, comité d'études,...). Il donne aussi des informations sur les projets et les publications retirées ou remplacées.

- Just Published CEI: www.iec.ch/online_news/justpub

Restez informé sur les nouvelles publications de la CEI. Just Published détaille deux fois par mois les nouvelles publications parues. Disponible en-ligne et aussi par email.

- Electropedia: www.electropedia.org

Le premier dictionnaire en ligne au monde de termes électroniques et électriques. Il contient plus de 20 000 termes et définitions en anglais et en français, ainsi que les termes équivalents dans les langues additionnelles. Egalement appelé Vocabulaire Electrotechnique International en ligne.

- Service Clients: www.iec.ch/webstore/custserv/custserv_entry-f.htm

Si vous désirez nous donner des commentaires sur cette publication ou si vous avez des questions, visitez le FAQ du Service clients ou contactez-nous:

Email: csc@iec.ch
Tél.: +41 22 919 02 11
Fax: +41 22 919 03 00



IEC 62491

Edition 1.0 2008-03

INTERNATIONAL STANDARD

NORME INTERNATIONALE

**Industrial systems, installations and equipment and industrial products –
Labelling of cables and cores**

**Systèmes industriels, installations et appareils et produits industriels –
Etiquetage des câbles et des conducteurs isolés**

INTERNATIONAL
ELECTROTECHNICAL
COMMISSION

COMMISSION
ELECTROTECHNIQUE
INTERNATIONALE

PRICE CODE
CODE PRIX

U

CONTENTS

FOREWORD.....	4
INTRODUCTION.....	6
1 Scope.....	7
2 Normative references.....	7
3 Terms and definitions.....	8
4 Rules.....	9
4.1 General requirements.....	9
4.2 Use of designated cable cores.....	10
4.3 Use of additional labelling.....	10
5 Identification labelling.....	11
5.1 General.....	11
6 Connection labelling.....	14
6.1 General.....	14
6.2 Local-end connection labelling.....	14
6.3 Remote-end connection labelling.....	15
6.4 Both-end connection labelling.....	16
7 Signal labelling.....	17
7.1 General.....	17
7.2 Labelling by signal designation.....	17
7.3 Labelling of cables for certain designated conductors.....	18
8 Composite labelling.....	19
9 Arrangement of additional labelling.....	20
9.1 General.....	20
9.2 Relative positions of the labelling.....	20
9.3 Characters to be used.....	20
10 Correspondence between labelling and documentation.....	21
11 Conformance to this standard.....	21
Annex A (informative) Examples of labelling.....	22
Bibliography.....	30
Figure 1 – Example of identification labelling of a single core cable (W23) and of a multi-core cable (W24) in which also the different cores are labelled.....	12
Figure 2 – Example of identification labelling of cores where the initial part of the reference designation has been partly omitted.....	13
Figure 3 – Example of local-end connection labelling.....	14
Figure 4 – Example of remote-end connection labelling for a connection inside a unit.....	15
Figure 5 – Example of remote-end connection labelling for a cable between different units.....	16
Figure 6 – Example of both-end connection labelling.....	17
Figure 7 – Example of local-end connection labelling combined with signal labelling.....	19
Figure 8 – Example of composite labelling in which both-end connection labelling is used together with identification labelling and signal labelling.....	19
Figure 9 – Examples of arrangements of labelling on cores or cables.....	20
Figure A.1 – Circuit diagram used as a basis for the examples.....	22

Figure A.2 – Example of identification labelling 23

Figure A.3 – Example of local-end labelling 24

Figure A.4 – Example of both-end connection labelling 25

Figure A.5 – Example of local end connection labelling with additional information 26

Figure A.6 – Example of signal labelling 27

Figure A.7 – Example of composite labelling..... 28

Figure A.8 – Example where use is made of the cable colours 29

Table 1 – Example of connection table in which the cable cores are identified by means of codes for their colour 10

Table 2 – Connection table corresponding to Figure 1 with labelling 12

Table 3 – Connection table corresponding to Figure 2 with labelling 13

Table 4 – Marking of certain designated conductors..... 18

Table 5 – Methods of labelling defined in this standard 21

INTERNATIONAL ELECTROTECHNICAL COMMISSION

**INDUSTRIAL SYSTEMS, INSTALLATIONS
AND EQUIPMENT AND INDUSTRIAL PRODUCTS –
LABELLING OF CABLES AND CORES**

FOREWORD

- 1) The International Electrotechnical Commission (IEC) is a worldwide organization for standardization comprising all national electrotechnical committees (IEC National Committees). The object of IEC is to promote international co-operation on all questions concerning standardization in the electrical and electronic fields. To this end and in addition to other activities, IEC publishes International Standards, Technical Specifications, Technical Reports, Publicly Available Specifications (PAS) and Guides (hereafter referred to as "IEC Publication(s)"). Their preparation is entrusted to technical committees; any IEC National Committee interested in the subject dealt with may participate in this preparatory work. International, governmental and non-governmental organizations liaising with the IEC also participate in this preparation. IEC collaborates closely with the International Organization for Standardization (ISO) in accordance with conditions determined by agreement between the two organizations.
- 2) The formal decisions or agreements of IEC on technical matters express, as nearly as possible, an international consensus of opinion on the relevant subjects since each technical committee has representation from all interested IEC National Committees.
- 3) IEC Publications have the form of recommendations for international use and are accepted by IEC National Committees in that sense. While all reasonable efforts are made to ensure that the technical content of IEC Publications is accurate, IEC cannot be held responsible for the way in which they are used or for any misinterpretation by any end user.
- 4) In order to promote international uniformity, IEC National Committees undertake to apply IEC Publications transparently to the maximum extent possible in their national and regional publications. Any divergence between any IEC Publication and the corresponding national or regional publication shall be clearly indicated in the latter.
- 5) IEC provides no marking procedure to indicate its approval and cannot be rendered responsible for any equipment declared to be in conformity with an IEC Publication.
- 6) All users should ensure that they have the latest edition of this publication.
- 7) No liability shall attach to IEC or its directors, employees, servants or agents including individual experts and members of its technical committees and IEC National Committees for any personal injury, property damage or other damage of any nature whatsoever, whether direct or indirect, or for costs (including legal fees) and expenses arising out of the publication, use of, or reliance upon, this IEC Publication or any other IEC Publications.
- 8) Attention is drawn to the Normative references cited in this publication. Use of the referenced publications is indispensable for the correct application of this publication.
- 9) Attention is drawn to the possibility that some of the elements of this IEC Publication may be the subject of patent rights. IEC shall not be held responsible for identifying any or all such patent rights.

International Standard IEC 62491 has been prepared by IEC technical committee 3: Information structures, documentation and graphical symbols.

The text of this standard is based on the following documents:

CDV	Report on voting
3/849/CDV	3/881/RVC

Full information on the voting for the approval of this standard can be found in the report on voting indicated in the above table.

This publication has been drafted in accordance with the ISO/IEC Directives, Part 2.

The committee has decided that the contents of this publication will remain unchanged until the maintenance result date indicated on the IEC web site under "<http://webstore.iec.ch>" in the data related to the specific publication. At this date, the publication will be

- reconfirmed,
- withdrawn,
- replaced by a revised edition, or
- amended.

INTRODUCTION

Additional labelling of cables and cores might be required within larger systems or installations with many cores of the same colour or with many cables, and where therefore the use of the designations provided by the cable manufacturer only would be ambiguous.

Due consideration should be given to the fact that additional labelling will cause additional cost, usually increasing with the number of characters in the labelling string and the number of different labelling elements. The available space may also impose restrictions with regard to the number of characters, their height and the length of the labelling. As a general rule the use of additional labelling should therefore be limited to a necessary minimum and be kept as short as practicable.

However, also the advantages and benefits should be taken into considerations in choosing additional labelling of cables and cores.

It is important to notice that a single machine or a system has different needs of information in the different phases of its lifecycles (assembling, production, service and maintenance).

Additional labelling of cables and cores gives the following advantages:

- the possibilities to communicate and identify signals and connections across different involved engineering disciplines and departments like:
 - process engineering,
 - software engineering,
 - electrical engineering,
 - mechanical/fluid engineering,
 - control engineering;
- minimizing the time used to locate an eventual error (and the reason for it) in the test phase;
- saving time when locating an eventual error (and the reason for it) in the service and maintenance phase;
- remove the doubt of which core should be connected to which terminal, when replacing components that are placed close to each other;
- if used in pre-planning, it gives a clear view for panel-builders, electricians/technicians; service/maintenance and system controllers which will minimize misunderstandings regarding connections.

Besides being used in connections between terminal blocks, labelling can also be used when single core cables connect components inside units as: cubicle, pulpit, case, etc.; such methods make possible:

- a rapid and secure cabling between the terminals of two objects;
- a rapid visual check of cabling, not necessarily looking up in the circuit diagrams;
- a correct and secure change of an object during the maintenance operations of plants.

INDUSTRIAL SYSTEMS, INSTALLATIONS AND EQUIPMENT AND INDUSTRIAL PRODUCTS – LABELLING OF CABLES AND CORES

1 Scope

This standard provides rules and guidelines for the labelling of cables and cores/conductors used in industrial installations, equipment and products, in order to maintain a clear relation between the technical documentation and the actual equipment and for other purposes. The following methods are described and designated:

- use of coloured cables and designated cores;
- additional identification labelling;
- additional connection labelling; and
- additional signal labelling.

The physical design of the labels, the material to be used for the labels as well as cable manufacturers' product bound marking of cables and cores are not part of this standard.

2 Normative references

The following referenced documents are indispensable for the application of this document. For dated references, only the edition cited applies. For undated references, the latest edition of the referenced document (including any amendments) applies.

IEC 60445, *Basic and safety principles for man-machine interface, marking and identification – Identification of equipment terminals and conductor terminations*

IEC 60757, *Code for designation of colours*

IEC 61082-1:2006, *Preparation of documents used in electrotechnology – Part 1: Rules*

IEC 61175, *Industrial systems, installations and equipment and industrial products – Designation of signals*

IEC 81346-1, *Industrial systems, installations and equipment and industrial products – Structuring principles and reference designations – Part 1: Basic rules (to be published)*

IEC 61666, *Industrial systems, installations and equipment and industrial products – Identification of terminals within a system*

ISO/IEC 646, *Information technology – ISO 7-bit coded character set for information interchange*

3 Terms and definitions

For the purposes of this document, the following terms and definitions apply.

3.1

conductor (of a cable)

part of a cable which has the specific function of carrying current

[IEV 461-01-01]

3.2

cable

assembly of one or more conductors and/or optical fibres, with a protective covering and possibly filling, insulating and protective material

[IEV 151-12-38]

3.3

core

assembly comprising a conductor with its own insulation (and screens if any)

[IEV 461-04-04]

3.4

terminal

conductive part of a device, electric circuit or electric network, provided for connecting that device, electric circuit or electric network to one or more external conductors

[IEV 151-12-12, modified]

3.5

terminal block

assembly of terminals in a housing or body of insulating material to facilitate interconnection between multiple conductors

[IEV 581-06-36]

3.6

terminal designation

identifier of a terminal with respect to the object to which it belongs, related to one aspect of the object.

[IEC 61666, 3.8]

3.7

signal designation

unambiguous identifier of a signal within a system

[IEC 61175, 3.2]

3.8

reference designation

identifier of a specific object with respect to the system of which the object is a constituent, based on one or more aspects of that system

3.9

labelling (of a cable or core)

label or labels attached to a cable or core indicating appropriate characteristics

3.10**identification labelling**

labelling showing the identifier of an object as a constituent of a specific installation, system, equipment or product

3.11**connection labelling**

labelling of a cable or core showing the identifier of the terminal, terminal block or equipment to which it is connected

3.12**local-end connection labelling**

system of labelling of cables and cores where the labelling of the end of the cable or core refers to the terminal, terminal block or equipment to which it is connected

3.13**remote-end connection labelling**

system of labelling of cables and cores where the labelling of the end of the cable or core refers to the terminal, terminal block or equipment to which the other end of it is connected

3.14**both-end connection labelling**

system of labelling of cables and cores where each end of a cable or core is provided with local-end connection labelling and remote-end connection labelling

3.15**signal labelling**

system of labelling of cables and cores used as a supplement to other labelling generally based on the signal(s) carried by the cable or core

3.16**composite labelling**

system of labelling where two or more of the identification labelling, connection labelling and signal labelling systems are used together

4 Rules**4.1 General requirements**

Cables and cores shall be recognizable at each end; it shall be possible to relate cables and cores to the technical documentation.

This may be carried out by:

- the designation and marking provided by the manufacturer of the cable, see 4.2, or
- an additional labelling, see 4.3.

Additional labelling might be required within larger systems or installations with many cores of the same colour or with many cables, and where therefore the use only of the designations provided by the cable or core manufacturer would be ambiguous.

The additional labelling shall be based on one or more of the following:

- the identifier of the cable or core, see Clause 5;
- the connection of the cable or core, see Clause 6, or
- the signal carried by the cable or core, see Clause 7.

4.2 Use of designated cable cores

Cable cores are often designated by the manufacturer applying methods such as:

- coloured insulation of the single cores;
- differently coloured (including multi-coloured) insulation of the cores of the cables, or
- differently numbered cores of cables.

These designations should, to the extent possible, be used for the identification of the cores. Additional labelling is in such cases normally not required.

The use of such designations shall be described in the documentation of the equipment in accordance with 7.5 and 9.3 of IEC 61082-1.

For the indication of the colours of cable cores in the documentation, the colour coding of IEC 60757 shall be applied.

NOTE The colour does not provide any information on where the core is to be connected. The connection information is in entirety to be found in associated connection table or connection diagram.

Table 1 shows an example of a connection table in which the colours (designated in accordance with IEC 60757) of the cable cores are used for the identification

Table 1 – Example of connection table in which the cable cores are identified by means of codes for their colour

Core colour	Local end	Remote end
GNYE	A4X1:PE	B4X1:PE
BK	A4X1:11	B4X1:33
BN	A4X1:17	B4X1:34
RD	A4X1:18	B4X1:35

4.3 Use of additional labelling

The additional labelling, where required, shall be one of the following types:

- identification labelling of the cable or core, see Clause 5;
- connection labelling of the cable or core, see Clause 6:
 - local-end connection labelling,
 - remote-end connection labelling,
 - both-end connection labelling;
- signal labelling of the cable or core, see Clause 7.
- Composite labelling, see Clause 8.

The method used shall be specified in the supporting documentation, see Clause 11.

Additional information, for example a reference to a page number of the circuit diagram, may be added on the label. The use of such additional information shall be explained in the technical documentation. For an example, see Clause A.5.

5 Identification labelling

5.1 General

The purpose of identification labelling is to show the identifier of the cable or core as a constituent of the system of which it is a part. The same labelling is valid and may be used all along a cable or core, even if it has junctions in its run.

The identification labelling does not provide any information on the connection. The connection information is in its entirety to be found in associated documentation.

NOTE 1 For further information on the preparation of the relevant document types, see IEC 61082-1.

The preferred identifier of a cable or core is a reference designation in accordance with IEC 81346-1. That standard provides further guidance on how to create unambiguous reference designations within an installation, system or equipment.

The reference designation can take different forms depending on, in which structure the core is identified and to which object the core is associated.

NOTE 2 “Cable numbers” are considered as a kind of reference designation. For further information, see IEC 81346-1.

The reference designation should normally be shown with relevant prefix sign, but this may be omitted if no ambiguity can arise.

NOTE 3 In the examples of this standard the first prefix sign of the reference designations (even if named “complete”) has been deliberately omitted in order not to give a reader the impression that a specific one is required for cables and connections.

EXAMPLE 1:

Cables between terminals belonging to the same object within which cable or core are identified. See Figure 1 and Table 2. The labels at each end as well as possible intermediate labels are shown.

- W23 is a single core cable with end labels and an intermediate label;
- W24 is a cable with end labels and intermediate labels. Also, the labels of each core of this cable are shown in the example. Note that the additional labelling of the cable cores could be omitted if the cable cores are unambiguously designated by numerals or colours by the cable manufacturer as described in 4.2.

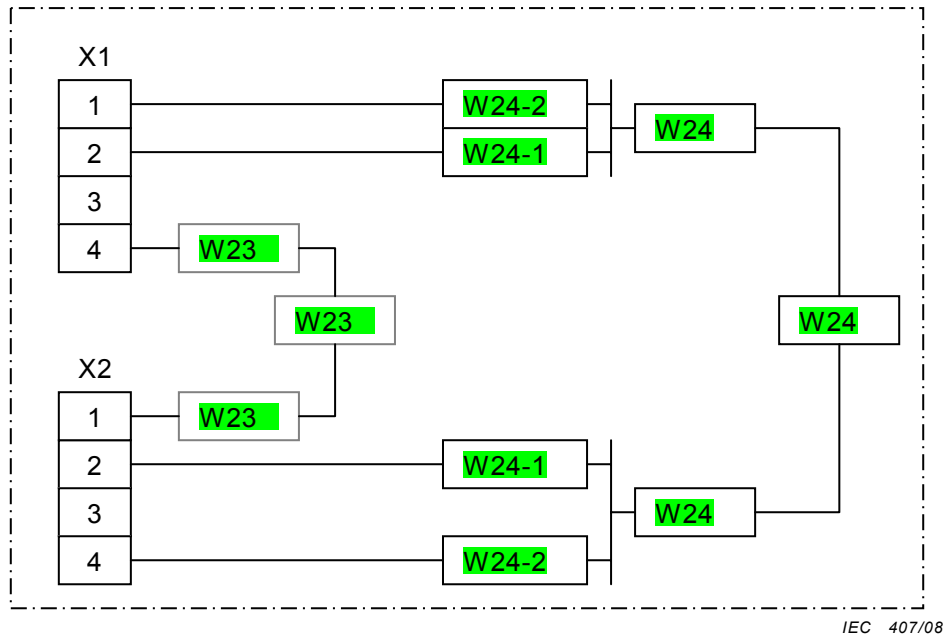

IEC 407/08

Figure 1 – Example of identification labelling of a single core cable (W23) and of a multi-core cable (W24) in which also the different cores are labelled

Table 2 – Connection table corresponding to Figure 1 with labelling

Cable reference designation	Core reference designation	Terminal	Terminal	Labelling
W23		X1:4	X2:1	W23
W24	-1	X1:2	X2:2	W24-1
	-2	X1:1	X2:4	W24-2

The initial part of the reference designation identifying the object within which the labelling is required to be unambiguous may be omitted if no ambiguity can occur. This requires that the reference designation of this object is clearly shown on a label related to that object.

NOTE 4 The complete reference designation of the cable or core is still the concatenation of the reference designation of the object and that of the cable or core.

EXAMPLES 2 (see Figure 2 and Table 3):

If the object of which the cable core is completely a constituent has a reference designation A1B2C3D4 and if the cable core is connecting two terminals within this unit, then the core labelling could be abbreviated to W23 while the full reference designation of that core is A1B2C3D4W23.

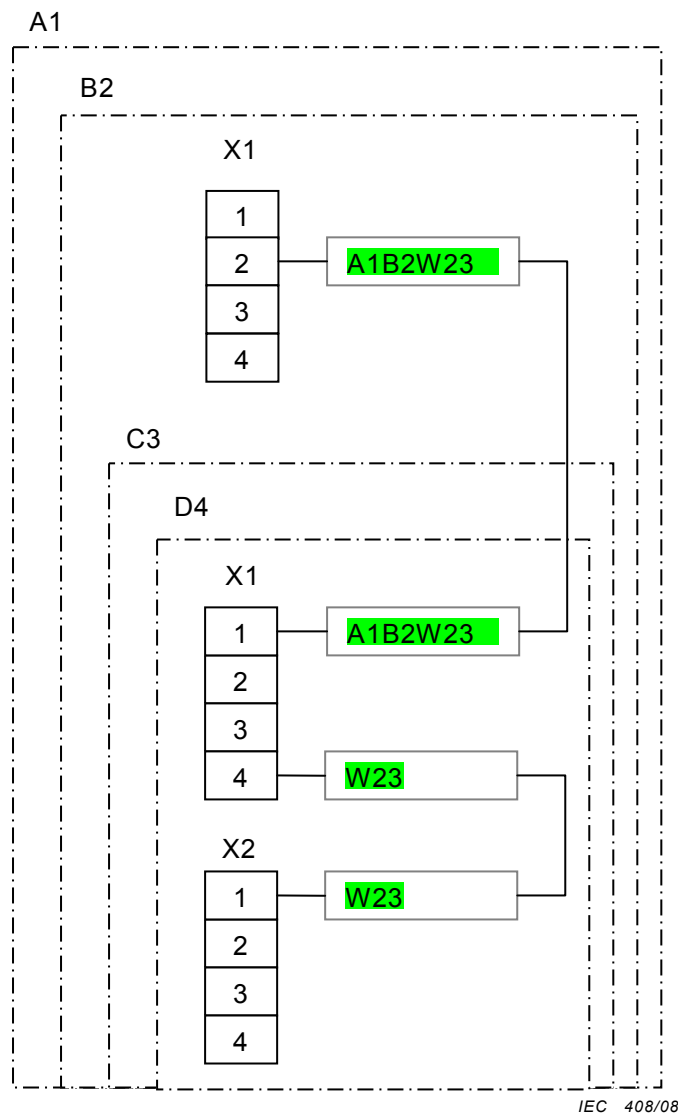

Figure 2 – Example of identification labelling of cores where the initial part of the reference designation has been partly omitted

Table 3 – Connection table corresponding to Figure 2 with labelling

Reference designation	Terminal	Terminal	Labelling
A1B2C3D4W23	A1B2C3D4X1:4	A1B2C3D4X2:1	W23
A1B2W23	A1B2X1:2	A1B2C3D4X1:1	A1B2W23

EXAMPLES 3 (see Figure 2 and Table 3):

If the core is crossing border lines between objects, the full reference designation that is relevant in this case needs to be presented on the label. For example the core connecting terminal block X1 inside A1B2C3D4 and terminal block X1 inside A1B2 is identified with respect to the object of which it is completely a constituent (i.e. A1B2) by A1B2W23.

6 Connection labelling

6.1 General

The purpose of connection labelling is to show, by means of the terminal designation, the identifier of the terminal to which the cable or cable core is (to be) connected.

For a multi-core cable it may only be possible to show the identifier of the terminal block or of the equipment to which the cable is to be connected.

The preferred identifier for a terminal is a terminal designation in accordance with IEC 61666. That standard provides further guidance on how to create unambiguous terminal designations within an installation or system.

The initial part of the terminal designation of the object within which the labelling is required to be unambiguous can be omitted if no ambiguity can occur.

6.2 Local-end connection labelling

In local-end connection labelling, each core end shall be labelled with the designation of the terminal to which it is connected. This permits the core to be removed and reconnected to the terminal without having to refer to a connection table or connection diagram.

Cables and cable cores inside a unit may be marked with the single-level reference designation of the terminal only, omitting the reference designation of the unit of which it is a constituent, see Figure 3. (The complete terminal designation may be A1S1X1:2 in the example.)

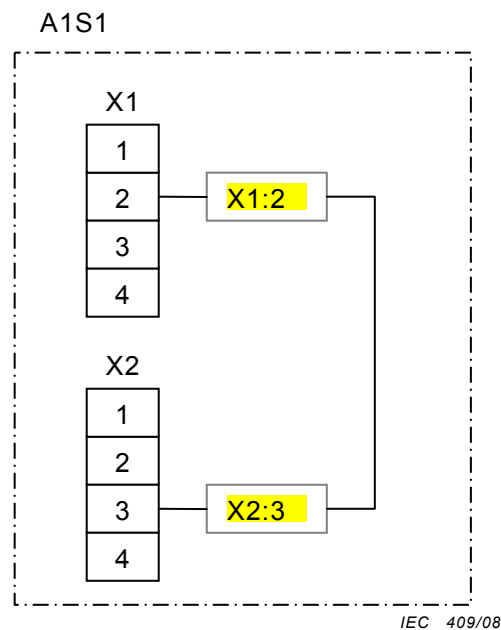

Figure 3 – Example of local-end connection labelling

6.3 Remote-end connection labelling

In remote-end connection labelling each cable or core end shall be labelled with the designation of the terminal to which the other end of the cable or core is connected. This may be convenient for fault location and maintenance work, but requires access to a connection table or connection diagram to enable any connection which has been removed to be replaced correctly.

Cables and cores inside a unit may be marked with the single-level reference designation of the terminal only, omitting the reference designation of the unit of which it is a constituent, see Figure 4. (The complete terminal designation may be A1S1X2:3 in the example.)

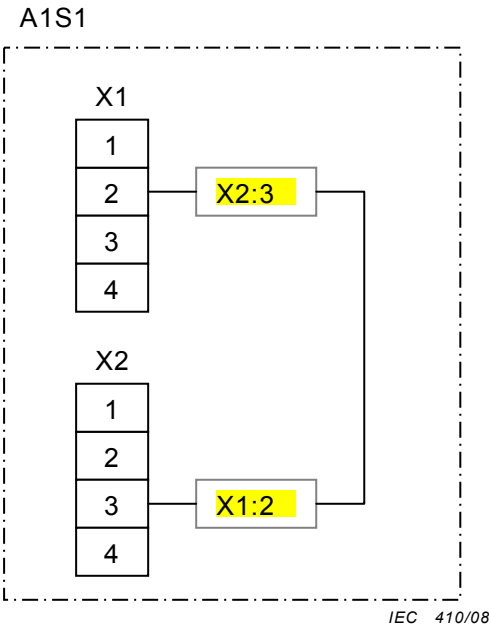

Figure 4 – Example of remote-end connection labelling for a connection inside a unit

If the core connects different units, complete reference designations of the remote end terminals shall be shown, see Figure 5.

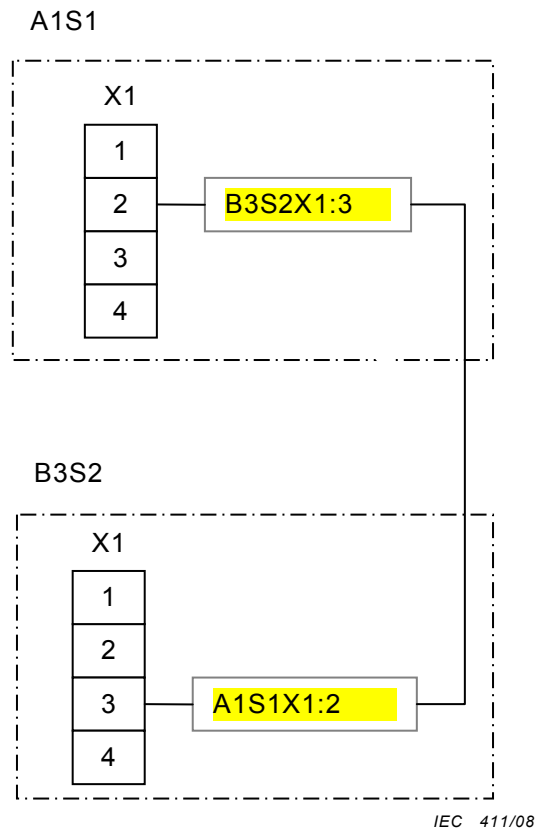

Figure 5 – Example of remote-end connection labelling for a cable between different units

6.4 Both-end connection labelling

In both-end connection labelling each cable or core end shall be marked with the terminal designation of the local-end as well as the remote-end terminal to which the core is connected, see Figure 6.

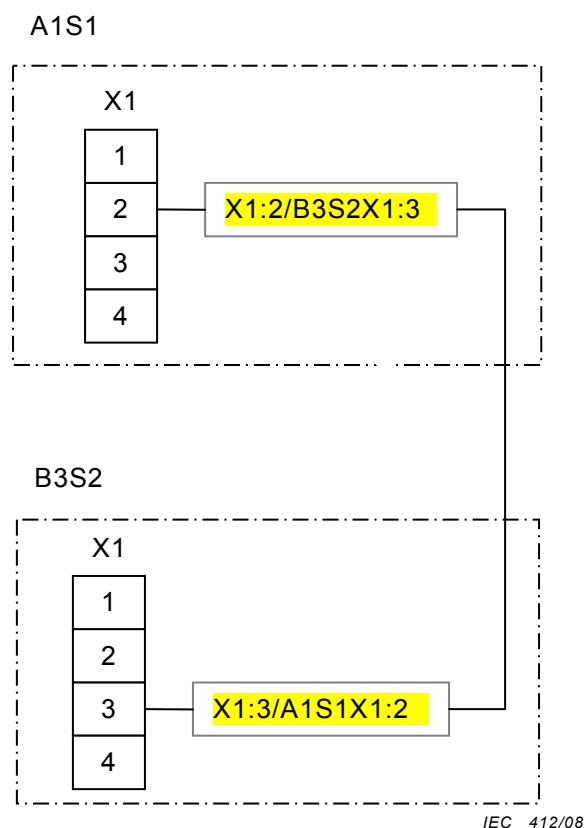

Figure 6 – Example of both-end connection labelling

7 Signal labelling

7.1 General

The purpose of signal labelling is to show the identifier(s) of the carried signal(s). Except for the labelling of certain designated cores, described in 7.3, signal labelling should be considered as a supplementary labelling.

The preferred identifier of a signal is a signal designation in accordance with IEC 61175. That standard provides further guidance on how to create unambiguous signal designations within an installation or system.

Constant-level power supplies are according to IEC 61175 to be considered as special types of signal. The labelling of the termination of certain cores according to IEC 60445 is therefore in this context considered as signal labelling.

7.2 Labelling by signal designation

Signal designations in accordance with IEC 61175 have the following structure:

Reference designation; signal name: variant (additional information)

Complete signal designations can be long and the information presented on a label attached to a cable or core should therefore be restricted to a purpose-related minimum.

In many cases the “signal name” or even the “basic signal name” (see IEC 61175 for the description) is sufficient, especially if it is shown in combination with an identifying labelling. Due consideration should also be given the fact that one core (pair) often transmits more than

one signal (e.g. CIRCUIT BREAKER ON – CIRCUIT BREAKER OFF), especially in digital applications.

EXAMPLE 1:

In the complete signal designation =A5W1M1;C_Motor_Stop the part “Motor_Stop” is the basic signal name that describes the “message”, that may be sufficient for the labelling.

7.3 Labelling of cables for certain designated conductors

The letter codes in Table 4 are specified in IEC 60445 for marking of the terminals intended for certain designated conductors. They are used as part of the signal designation for constant-level power supplies, and should be used for signal labelling of corresponding cables or cores if required.

Table 4 – Marking of certain designated conductors

Labelling	Conductor
L1	Phase 1 for a.c. supply
L2	Phase 2 for a.c. supply
L3	Phase 3 for a.c. supply
M	Mid-point conductor for a.c. supply
N	Neutral for a.c. supply
L+	Positive for d.c. supply
L -	Negative for d.c. supply
PE	Protective conductor
PEN	Protective PEN conductor (see definition in IEC 60050-195)
PEL	Protective PEL conductor (see definition in IEC 60050-195)
PEM	Protective PEM conductor (see definition in IEC 60050-195)
PB	Protective bonding conductor (see definition in IEC 60050-195)
PBE	Earthed protective bonding conductor
PBU	Unearthed protective bonding conductor
FE	Functional earthing conductor
FB	Functional bonding conductor

EXAMPLE 1:

Figure 7 shows a case where local-end connection labelling is combined with signal labelling: the actual conductor is used for functional earth.

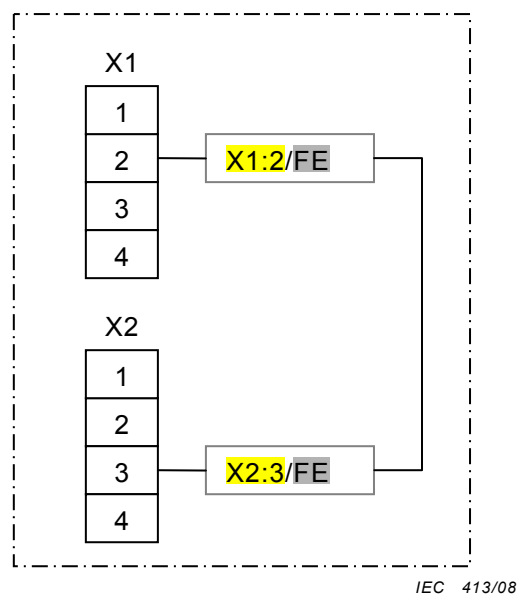

Figure 7 – Example of local-end connection labelling combined with signal labelling

8 Composite labelling

Composite labelling shall consist of the combination of two or more labels like an identification labelling and a connection labelling. The connection labelling might be local-end, remote-end or both-end.

For any intermediate label that may be required along the cable local-end and remote-end labelling as well as signal labelling may be omitted. See Figure 8.

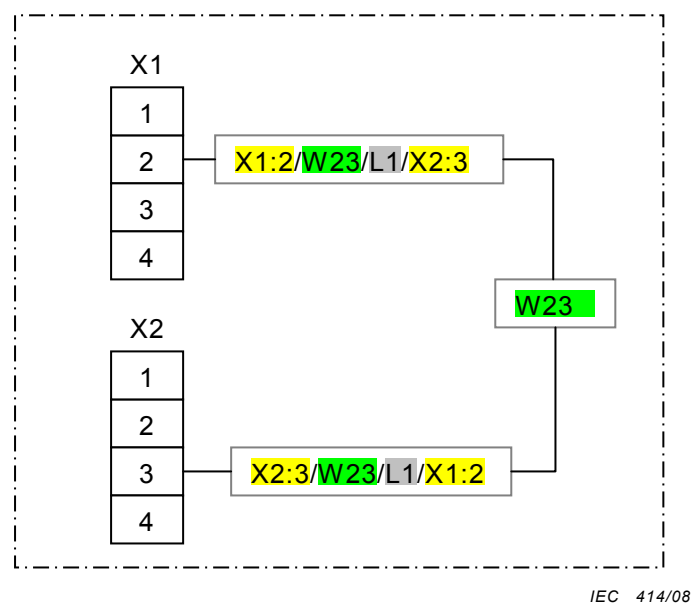

Figure 8 – Example of composite labelling in which both-end connection labelling is used together with identification labelling and signal labelling

9 Arrangement of additional labelling

9.1 General

Additional labelling shall be placed at the ends of cables or cores and, where necessary for reasons of clarity, at visible points along their length.

If a labelling consists of various elements, each of these shall be distinguished from others by, for example (see Figure 9):

- arranging each element on a separate row;
- separating the elements by an appropriate sign, e.g. a solidus (/);
- separating the elements by sufficient space (blank signs);
- the use of recognizable different typographic characters.

NOTE The labelling in Figure 9 refers to the same example as in Figure 8.

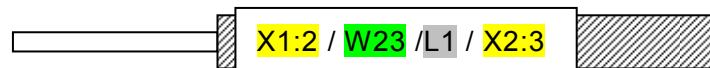

Separation by character solidus " / "

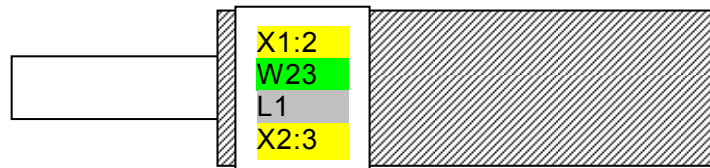

Arrangement on separate rows

IEC 415/08

Figure 9 – Examples of arrangements of labelling on cores or cables.

9.2 Relative positions of the labelling

The different labels shall be arranged in the following order, starting with the local end connection labelling closest to the local terminal:

local-end connection / **identification** / **signal** / **remote-end connection**

or

local-end connection
identification
signal
remote-end connection

This order shall be maintained also if one or more of the labels are omitted.

9.3 Characters to be used

The information used for labelling shall correspond to the information presented in related documentation, normally prepared in accordance with IEC 61082-1. This includes that the characters should be restricted to the characters in the ISO/IEC 646 7-bit character set, basic code table, excluding control characters and national replacement characters.

10 Correspondence between labelling and documentation

In the documentation shall be stated which type of labelling system is applied (see Clause 11) and, if applicable, how the different kinds of labelling are separated or else recognized (see Clause 9).

If the documentation is prepared in accordance with IEC 61082-1, then all the identifiers on which the labelling is based (i.e. reference designations, terminal designations, signal designations) are present in the documentation. There is therefore no need to make any extra inscriptions with regard to the labelling.

11 Conformance to this standard

Conformance to this standard shall be expressed by stating the method of labelling applied in accordance with Table 5.

Table 5 – Methods of labelling defined in this standard

Method	Clause/subclause	Description	Remarks
0	-	No labelling	All cables can be visibly followed.
A	4.2	Use of designated cables or cores	No additional labelling. The permanent marking of the insulation by means of colours or numerals is used.
R	5	Identification labelling by means of reference designation (including cable number)	Additional labelling
CL	6.2	Local-end connection labelling	Additional labelling
CR	6.3	Remote-end connection labelling	Additional labelling
CB	6.4	Both-end connection labelling	Additional labelling
S	7	Signal labelling	Additional labelling
Specify by means of two or more of the methods above	8	Composite labelling	Additional labelling

Annex A (informative)

Examples of labelling

A.1 General

This annex provides a number of examples applying the different labelling methods of the cables within an assembled unit.

The circuit diagram in Figure A.1 is used as a common basis for the examples of labelling. In order to facilitate the differentiation of the designations appearing in the diagram, they are shown with a coloured background as follows:

- yellow: reference designations of objects to which connections are made;
- green: reference designations of cables, and
- grey: signal designations.

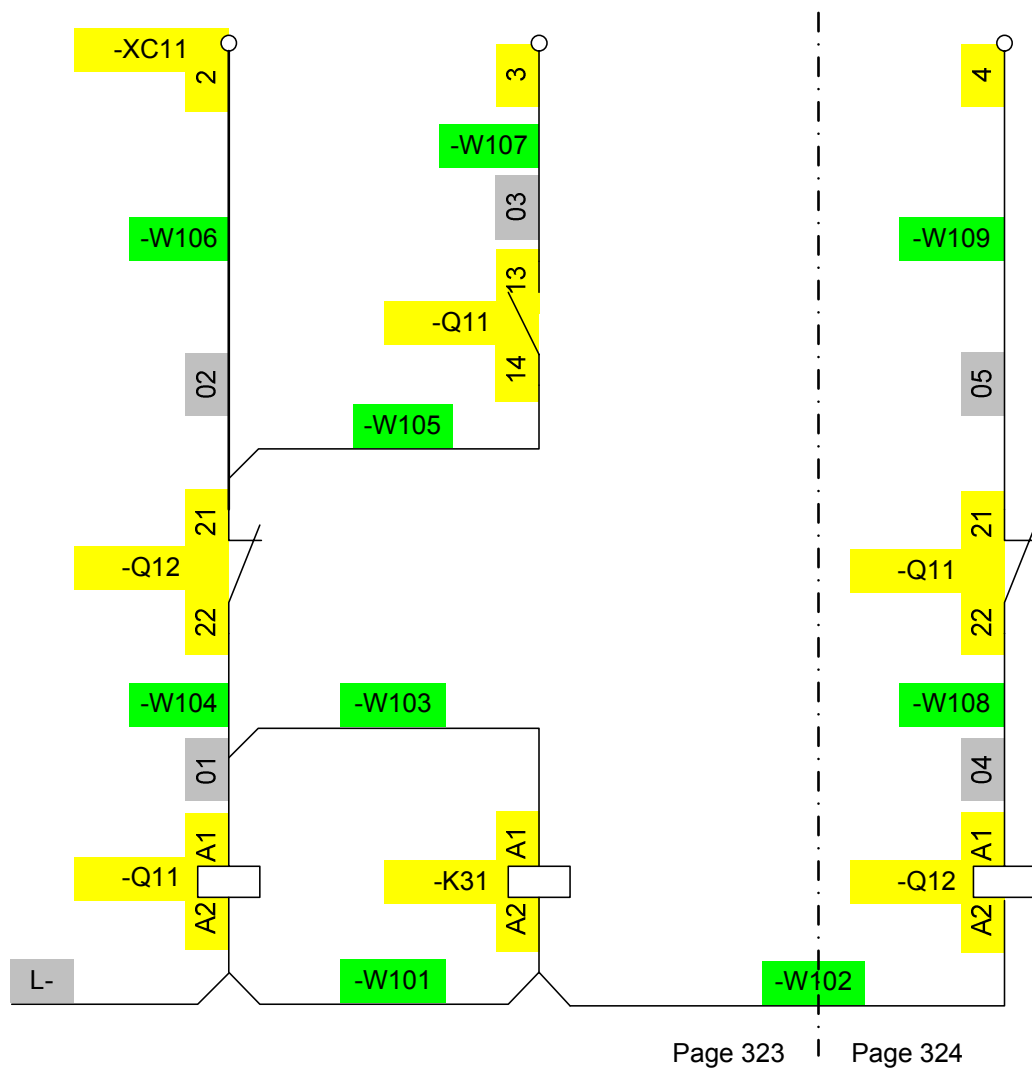

Page 323

Page 324

IEC 416/08

Figure A.1 – Circuit diagram used as a basis for the examples

A.2 Identification labelling (method R)

The basis for the identification labelling is the reference designation of the cables or cores in accordance with Clause 5. In the example, the reference designations are assigned in the product-oriented structure and for the cables they consist of 3-character numbers.

In the following example, the prefix signs of the reference designations have been omitted on the labels since all reference designations in this case are related to the product-oriented structure.

See Figure A.2.

NOTE In the “Illustration of labelling” the labels in the right hand end of the cable (end 2) are shown upside down in order to properly illustrate the prescribed arrangement order in both ends in accordance with 9.2. This phenomenon appears in an illustration when both ends are shown together on a straight cable, but has no other practical consequences.

Cable	Signal	End 1			End 2			Illustration of labelling
		Object	Term.	Label	Object	Term.	Label	
-W101	L-	-Q11	:A2	101	-K31	:A2	101	
-W102	L-	-K31	:A2	102	-Q12	:A2	102	
-W103	01	-Q11	:A1	103	-K31	:A1	103	
-W104	01	-Q11	:A1	104	-Q12	:22	104	
-W105	02	-Q12	:21	105	-Q11	:14	105	
-W106	02	-Q12	:21	106	-XC11	:2	106	
-W107	03	-Q12	:13	107	-XC11	:3	107	
-W108	04	-Q12	:A1	108	-Q11	:22	108	
-W109	05	-Q11	:21	109	-XC11	:4	109	

Figure A.2 – Example of identification labelling

IEC 417/08

A.3 Local-end connection labelling (method CL)

The basis for the labelling is the reference designation for the terminal to which the cable is connected in accordance with 6.2. This labelling is applied at both ends of the cable.

In the following example the prefix signs of the reference designations have been omitted on the labels since all reference designations in this case are related to the product-oriented structure.

See

Figure A.3.

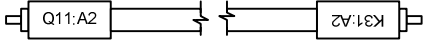
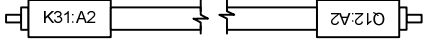
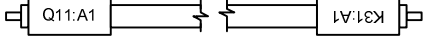
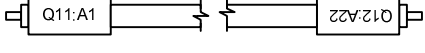
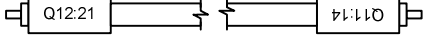
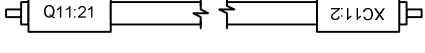
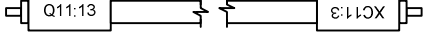
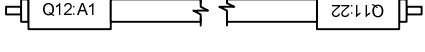
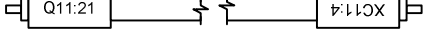
Cable	Signal	End 1			End 2			Illustration of labelling
		Object	Term.	Label	Object	Term.	Label	
-W101	L-	-Q11	:A2	Q11:A2	-K31	:A2	K31:A2	
-W102	L-	-K31	:A2	K31:A2	-Q12	:A2	Q12:A2	
-W103	01	-Q11	:A1	Q11:A1	-K31	:A1	K31:A1	
-W104	01	-Q11	:A1	Q11:A1	-Q12	:22	Q12:A22	
-W105	02	-Q12	:21	Q12:21	-Q11	:14	Q11:14	
-W106	02	-Q12	:21	Q12:21	-XC11	:2	XC11:2	
-W107	03	-Q11	:13	Q11:13	-XC11	:3	XC11:3	
-W108	04	-Q12	:A1	Q12:A1	-Q11	:22	Q11:22	
-W109	05	-Q11	:21	Q11:21	-XC11	:4	XC11:4	

IEC 418/08

Figure A.3 – Example of local-end labelling

A.4 Both-end connection labelling (method CB)

The basis for both-end connection labelling is the reference designations of the local-end terminal and that of the opposite, remote end, terminal of the cable in accordance with 6.4. This labelling is applied at both ends of the cable.

In the following example the prefix signs of the reference designations have been omitted on the labels since all reference designations in this case are related to the product-oriented structure.

See

Figure A.4. Note that the order of the two parts of the labelling is different in the two ends.

End 1			End 2			Illustration of labelling
Object	Term.	Label	Object	Term.	Label	
-Q11	:A2	Q11:A2/K31:A2	-K31	:A2	K31:A2/Q11:A2	
-K31	:A2	K31:A2/Q12:A2	-Q12	:A2	Q12:A2/K31:A2	
-Q11	:A1	Q11:A1/K31:A1	-K31	:A1	K31:A1/Q11:A1	
-Q11	:A1	Q11:A1/Q12:A22	-Q12	:22	Q12:A22/Q11:A1	
-Q12	:21	Q12:21/Q11:14	-Q11	:14	Q11:14/Q12:21	
-Q12	:21	Q12:21/XC11:2	-XC11	:2	XC11:2/Q11:21	
-Q11	:13	Q11:13/XC11:3	-XC11	:3	XC11:3/Q11:13	
-Q12	:A1	Q12:A1/Q11:22	-Q11	:22	Q11:22/Q12:A1	
-Q11	:21	Q11:21/XC11:4	-XC11	:4	XC11:4/Q11:21	

IEC 419/08

Figure A.4 – Example of both-end connection labelling

A.5 Attachment of additional information

This example illustrates how additional information might be attached to connection labelling (CL).

In this example, the additional information consists of the relevant page number of the circuit diagram on which the point of connection appears.

In order to distinguish this additional information from the standardized notation, it is shown within brackets.

NOTE Adding the page number of a specific document to the label as additional information is practicable only if stable page numbering is applied in the referenced document. If a CAE system is used that can assign page numbers dynamically, a final (AS BUILT) document needs to be used.

See Figure A.5.

Page	End 1			End 2			Illustration of labelling
	Object	Term.	Label	Object	Term.	Label	
323	-Q11	:A2	Q11:A2[323]	-K31	:A2	K31:A2[323]	
323+ 324*	-K31	:A2	K31:A2[323]	-Q12	:A2	Q12:A2[324]	
323	-Q11	:A1	Q11:A1[323]	-K31	:A1	K31:A1[323]	
323	-Q11	:A1	Q11:A1[323]	-Q12	:22	Q12:A22[323]	
323	-Q12	:21	Q12:21[323]	-Q11	:14	Q11:14[323]	
323	-Q11	:21	Q11:21[323]	-XC11	:2	XC11:2[323]	
323	-Q11	:13	Q11:13[323]	-XC11	:3	XC11:3[323]	
324	-Q12	:A1	Q12:A1[324]	-Q11	:22	Q11:22[324]	
324	-Q11	:21	Q11:21[324]	-XC11	:4	XC11:4[324]	

IEC 420/08

* For this connection, one end of the cable appears on one page and the other end of the cable on another.

Figure A.5 – Example of local end connection labelling with additional information

A.6 Signal labelling (method S)

The basis for the labelling is the signal carried by the cable in accordance with Clause 7.

Cables carrying the same signal have the same designation. As a consequence, a group of connected cables (cable segments) carrying the same electrical potential (the same “electrical point”) are all having the same designation from a signal perspective.

In the example, such groups of cables have been designated by 2-character numbers. Cables carrying supply voltages have been designated in accordance with 7.3.

See

Figure A.6.

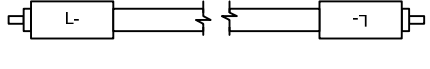
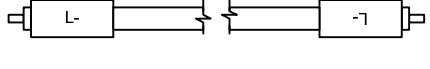
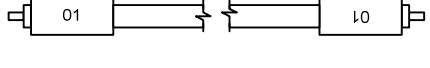
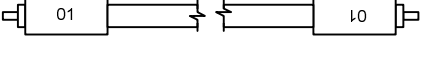
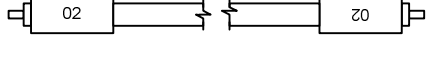
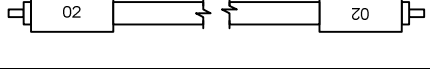
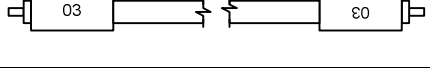
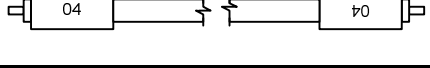
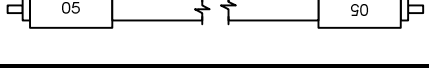
Cable	Signal	End 1			End 2			Illustration of labelling
		Object	Term.	Label	Object	Term.	Label	
-W101	L-	-Q11	:A2	L-	-K31	:A2	L-	
-W102	L-	-K31	:A2	L-	-Q12	:A2	L-	
-W103	01	-Q11	:A1	01	-K31	:A1	01	
-W104	01	-Q11	:A1	01	-Q12	:22	01	
-W105	02	-Q12	:21	02	-Q11	:14	02	
-W106	02	-Q12	:21	02	-XC11	:2	02	
-W107	03	-Q11	:13	03	-XC11	:3	03	
-W108	04	-Q12	:A1	04	-Q11	:22	04	
-W109	05	-Q11	:21	05	-XC11	:4	05	

IEC 421/08

Figure A.6 – Example of signal labelling

A.7 Composite labelling (method R + S)

The basis for this kind of labelling is Clause 8.

In this example, the combination of identification labelling (see Clause A.2) and signal labelling (see Clause A.6) is illustrated. This is one of the possible combinations.

See

Figure A.7.

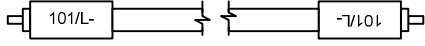
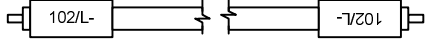
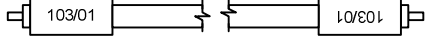
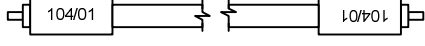
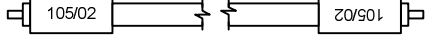
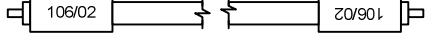
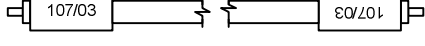
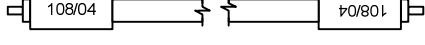
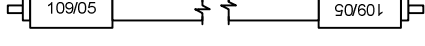
Cable	Signal	End 1			End 2			Illustration of labelling
		Object	Term.	Label	Object	Term.	Label	
-W101	L-	-Q11	:A2	101/L-	-K31	:A2	101/L-	
-W102	L-	-K31	:A2	102/L-	-Q12	:A2	102/L-	
-W103	01	-Q11	:A1	103/01	-K31	:A1	103/01	
-W104	01	-Q11	:A1	104/01	-Q12	:22	104/01	
-W105	02	-Q12	:21	105/02	-Q11	:14	105/02	
-W106	02	-Q12	:21	106/02	-XC11	:2	106/02	
-W107	03	-Q11	:13	107/03	-XC11	:3	107/03	
-W108	04	-Q12	:A1	108/04	-Q11	:22	108/04	
-W109	05	-Q11	:21	109/05	-XC11	:4	109/05	

IEC 422/08

Figure A.7 – Example of composite labelling









A.8 Use of cable colours (method A)

The basis for this kind of identification is 4.2.

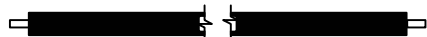
In the following example, colours have been used to identify the cables. In the example, cables the same colour are used for cables carrying the same signal or supply voltage.

See

Figure A.8.

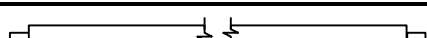
Cable	Signal	End 1			End 2			Illustration
		Object	Term.	Colour	Object	Term.	Colour	
-W101	L-	-Q11	:A2	BLUE	-K31	:A2	BLUE	
-W102	L-	-K31	:A2	BLUE	-Q12	:A2	BLUE	
-W103	01	-Q11	:A1	BLACK	-K31	:A1	BLACK	
-W104	01	-Q11	:A1	BLACK	-Q12	:22	BLACK	
-W105	02	-Q12	:21	BROWN	-Q11	:14	BROWN	
-W106	02	-Q12	:21	BROWN	-XC11	:2	BROWN	
-W107	03	-Q11	:13	GREEN	-XC11	:3	GREEN	
-W108	04	-Q12	:A1	GREY	-Q11	:22	GREY	
-W109	05	-Q11	:21	WHITE	-XC11	:4	WHITE	

IEC 423/08

Figure A.8 – Example where use is made of the cable colours

Bibliography

IEC 60050-151, *International Electrotechnical Vocabulary – Part 151: Electrical and magnetic devices*

IEC 60050-195, *International Electrotechnical Vocabulary – Part 195: Earthing and protection against shock*

IEC 60050-461, *International Electrotechnical Vocabulary – Chapter 461: Electric cables*

IEC 60050-581, *Advance edition of the International Electrotechnical Vocabulary – Chapter 581: Electromechanical components for electronic equipment*

IEC 60446, *Basic and safety principles for man-machine interface, marking and identification – Identification of conductors by colours or alphanumerics*

以上内容仅为本文档的试下载部分，为可阅读页数的一半内容。如要下载或阅读全文，请访问：<https://d.book118.com/598004043034006062>